

MOSAIC CONDOMINIUM

THE NORTHWESTERLY 75 FEET OF THE NORTHEASTERLY 15 FEET OF LOT 7 AND THE NORTHWESTERLY 55 FEET OF LOT 8, BLOCK 244, "CITY OF PORTLAND", SITUATED IN THE NORTHEAST QUARTER OF SECTION 4, TOWNSHIP 1 SOUTH, RANGE 1 EAST, WILLAMETTE MERIDIAN, CITY OF PORTLAND, MULTNOMAH COUNTY, STATE OF OREGON. MAY 28, 2003
SCALE: 1" = 10'

LEGEND

- FOUND AND HELD BRASS SCREW WITH 3/4" BRASS WASHER MARKED "W.B. WELLS & ASSOC.", SET IN SN-58672
- FOUND AND HELD 5/8" IRON ROD WITH YELLOW PLASTIC CAP MARKED "W.B. WELLS & ASSOC., INC.", SET IN SN-58672

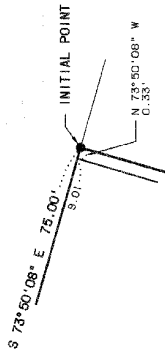

CORNER DETAIL
NOT TO SCALE

INDEX

- PAGE 1 - BOUNDARY, BUILDING LOCATION
- PAGE 2 - STORAGE SPACE DETAIL
- PAGE 3 - LOWER AND MAIN LEVELS
- PAGE 4 - SECOND AND THIRD FLOORS
- PAGE 5 - FOURTH AND FIFTH FLOORS
- PAGE 6 - SIXTH AND SEVENTH FLOORS
- PAGE 7 - PENTHOUSE LEVEL AND SECTION A-A
- PAGE 8 - SURVEYOR'S CERTIFICATE, NARRATIVE, DECLARATION, ACKNOWLEDGEMENT, APPROVALS

NOTES

1. BUILDING CORNERS ARE PERPENDICULAR.
2. BUILDING DIMENSIONS AND TIES SHOWN ARE TO THE EXTERIOR PERIMETER OF MAIN BUILDING WALL LINE.
3. PORTIONS OF BUILDINGS ARE WITHIN THE RIGHT-OF-WAYS OF S.E. 11TH AVENUE AND S.W. COLUMBIA STREET, CITY OF PORTLAND BUREAU OF PLANNING AND THE OFFICE OF TRANSPORTATION ACCEPTS DEFINITION OF ORIEL WINDOWS AS DEFINED IN UNIFORM BUILDING CODE SECTION 3204, STRUCTURAL SPECIALTY CODE. SAID SECTION ALLOWS A PROJECTION OF 4 FEET INTO RIGHT-OF-WAY OF ORIEL (BAY) WINDOWS.

W.B. WELLS AND ASSOCIATES, INC.
SURVEYORS/ENGINEERS/PLANNERS
4230 N.E. FREMONT STREET
PORTLAND, OREGON 97213
PHONE (503) 284-2830
FAX (503) 284-2830
FILE NO. 00-250 DTN PAGE 1 OF 8

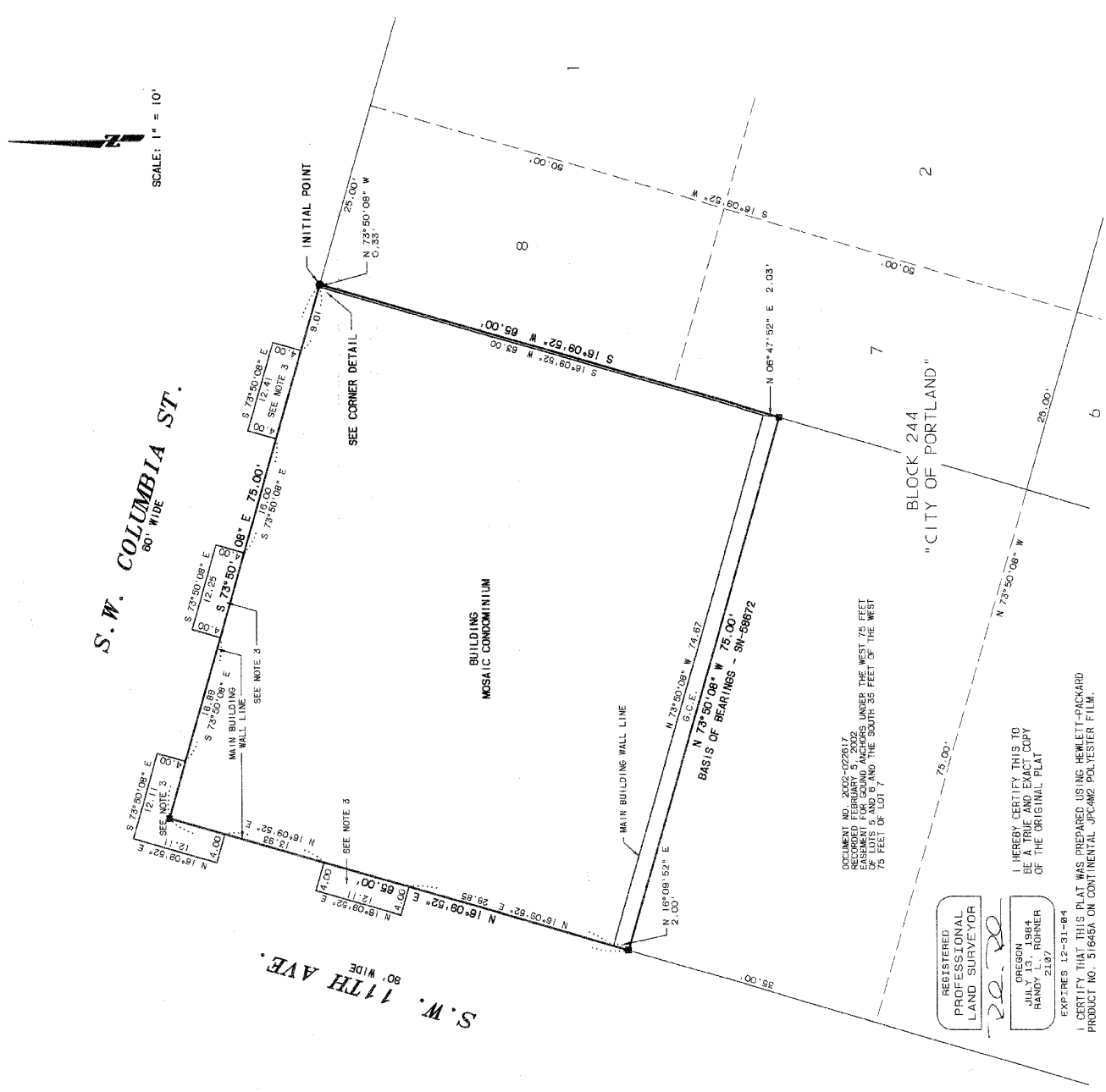

DOCUMENT NO. 2002-022617
RECORDED FEBRUARY 14, 2003
UNDER THE WEST 75 FEET OF LOTS 5 AND 6 AND THE SOUTH 35 FEET OF THE WEST 75 FEET OF LOT 7

REGISTERED PROFESSIONAL LAND SURVEYOR
2003
OREGON
RANBY ROHNER
2167
EXPIRES 12-31-04

I HEREBY CERTIFY THIS TO BE A TRUE AND CORRECT COPY OF THE ORIGINAL PLAN
I CERTIFY THAT THIS PLAN WAS PREPARED USING HEWLETT-PACKARD PRODUCT NO. 51645A ON CONTINENTAL JPC4M2 POLYESTER FILM.

MOSAIC CONDOMINIUM

THE NORTHWESTERLY 75 FEET OF THE NORTHWESTERLY 1/4 SECTION OF LOT 7 AND THE NORTHWESTERLY 17 1/2 FEET OF BLOCK 244, CITY OF PORTLAND, SITUATED IN THE NORTHEAST QUARTER OF SECTION 4, TOWNSHIP 1 SOUTH, RANGE 1 EAST, WILLAMETTE MERIDIAN, CITY OF PORTLAND, MULTNOMAH COUNTY, STATE OF OREGON. MAY 13, 2003
SCALE: 1" = 10'

NOTES

1. BUILDING CORNERS ARE PERPENDICULAR, OR AS NOTED.
2. ENTRIES AND PATIOS ARE LIMITED COMMON ELEMENTS AND PERTAIN TO THE UNIT TO WHICH THEY ADJOIN.
3. FINISHED FLOOR ELEVATIONS ARE FROM CITY OF PORTLAND BENCHMARK NO. 2549, LOCATED AT THE SOUTHEAST CORNER OF THE INTERSECTION OF S.W. 2TH AVENUE AND S.W. CLAY STREET, ELEVATION 157.466 FEET, CITY OF PORTLAND DATUM.
4. VERTICAL BOUNDARIES OF UNITS ARE FROM SURFACE OF UNFINISHED FLOORING TO UNFINISHED CEILING. HORIZONTAL BOUNDARIES OF UNITS ARE TO CENTER OF WALLS BETWEEN UNITS, INTERIOR FACE OF EXTERIOR WALLS, INTERIOR FACE OF EXTERIOR WALLS AND TO THE EXTERIOR FACE OF STUDS OF ALL OTHER WALLS.

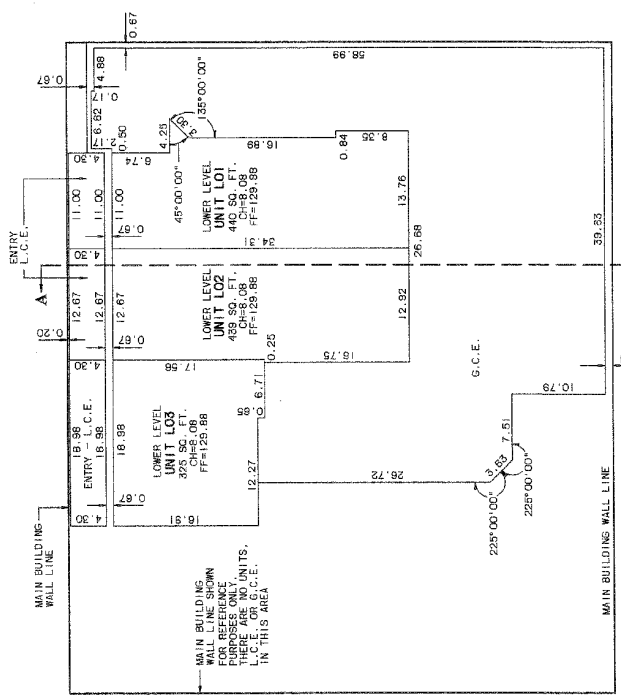

LOWER LEVEL

EXTERIOR WALLS 0.00 #IDE UNLESS SHOWN OTHERWISE

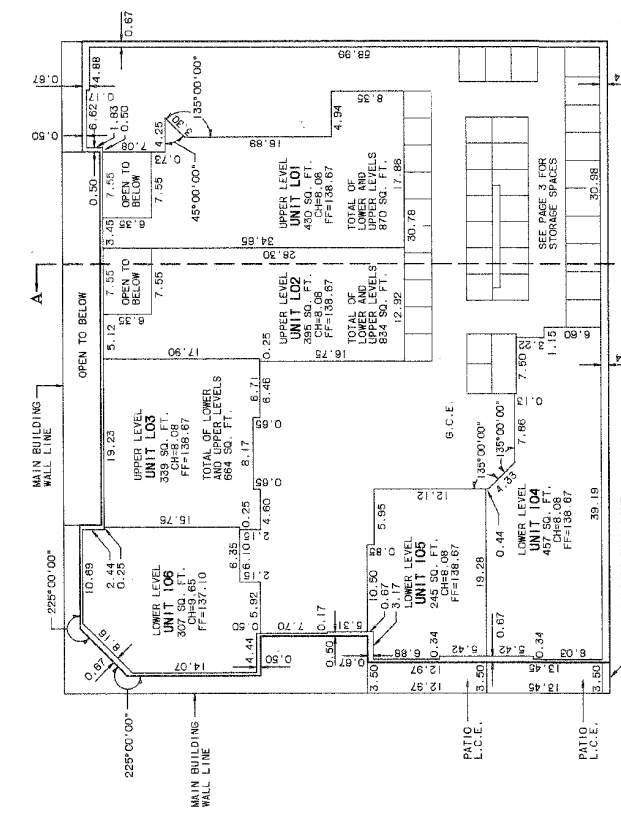

MAIN LEVEL

EXTERIOR WALLS 0.33 #IDE UNLESS SHOWN OTHERWISE

LEGEND

- FF FINISHED FLOOR ELEVATION
- CH CEILING HEIGHT
- SQ. FT. SQUARE FEET
- L.C.E. LIMITED COMMON ELEMENT
- G.C.E. GENERAL COMMON ELEMENT

REGISTERED PROFESSIONAL LAND SURVEYOR
R.L.R.
OREGON
JULY 13, 1984
RANDY L. ROHNER
2107

I HEREBY CERTIFY THIS TO BE A TRUE AND EXACT COPY OF THE ORIGINAL PLAT

I CERTIFY THAT THIS PLAT WAS PREPARED USING HEWLETT-PACKARD PRODUCT NO. 51649A ON CONTINENTAL JPC-M2 POLYESTER FILM.

W.R. WELLS AND ASSOCIATES, INC.
SURVEYORS/ENGINEERS/PLANNERS
4230 N.E. FREMONT STREET
PORTLAND, OREGON 97213
PHONE 1-503-284-8888
FAX 1-503-284-8830
FILE NO. CO-250 DTM

MOSAIC CONDOMINIUM

THE NORTHWESTERLY 75 FEET OF THE NORTHEASTERLY 1/4 SECTION 15, FEET OF LOT 7 AND THE NORTHWESTERLY 75 FEET OF LOT 8, BLOCK 244, CITY OF PORTLAND, SITUATED IN THE NORTHEAST QUARTER OF SECTION 4, TOWNSHIP 1 SOUTH, RANGE 1 EAST, WILLAMETTE MERIDIAN, CITY OF PORTLAND, MULTNOMAH COUNTY, STATE OF OREGON, MAY 13, 2003 SCALE: 1" = 5'

NOTES

- STORAGE SPACES ARE LIMITED COMMON ELEMENTS AND ARE ASSIGNED IN THE DECLARATION.

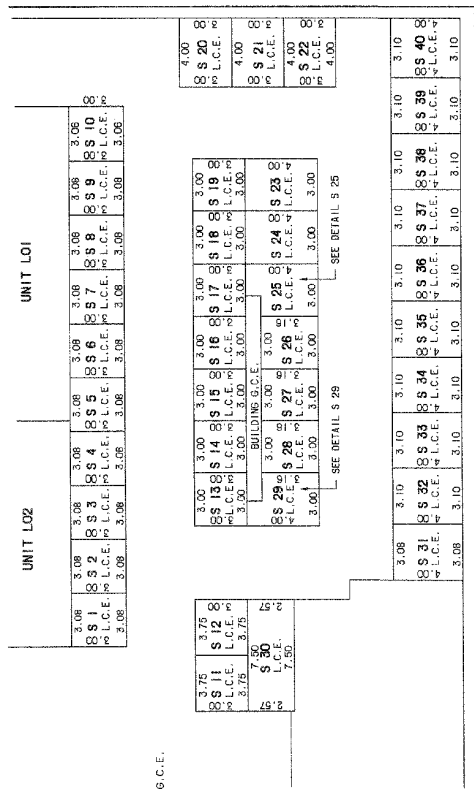

STORAGE SPACE DETAIL

REGISTERED PROFESSIONAL LAND SURVEYOR
 JULY 13, 1984
 RANDY L. ROHNER
 EXPIRES 12-31-04

I HEREBY CERTIFY THIS TO BE A TRUE AND EXACT COPY OF THE ORIGINAL PLAT

I CERTIFY THAT THIS PLAT WAS PREPARED USING HEWLETT-PACKARD PRODUCT NO. 51945A ON CONTINENTAL JPC-962 POLYESTER FILM.

LEGEND

- G.C.E. GENERAL COMMON ELEMENT
- L.C.E. LIMITED COMMON ELEMENT
- S STORAGE SPACE

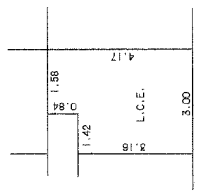
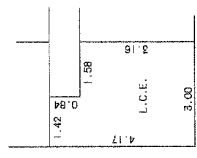

W. B. WELLS AND ASSOCIATES, INC.
 SURVEYORS/ENGINEERS/PLANNERS
 4230 N.E. FREMONT STREET
 PORTLAND, OREGON 97213
 PHONE (503) 244-8888
 FAX (503) 284-6830
 DTW

FILE NO. 00-250
 PAGE 3 OF 8

MOSAIC CONDOMINIUM

THE NORTHWESTERLY 75 FEET OF THE NORTHEASTERLY 1/8 FEET OF LOT 7 AND THE NORTHWESTERLY 55 FEET OF LOT 8, BLOCK 244, "CITY OF PORTLAND", SITUATED IN THE NORTHEAST QUARTER OF SECTION 4, TOWNSHIP 1 SOUTH, RANGE 1 EAST, WILLAMETTE MERIDIAN, CITY OF PORTLAND, MULTNOMAH COUNTY, STATE OF OREGON. MAY 13, 2003
SCALE: 1" = 10'

NOTES

1. BUILDING CORNERS ARE PERPENDICULAR, OR AS NOTED.
2. PATIOS ARE LIMITED COMMON ELEMENTS AND PERTAIN TO THE UNIT TO WHICH THEY ADJOIN.
3. FINISHED FLOOR ELEVATIONS ARE FROM CITY OF PORTLAND BENCHMARK NO. 2549, LOCATED AT THE SOUTHWEST CORNER OF THE INTERSECTION OF S.W. 12TH AVENUE AND S.W. CLAY STREET. ELEVATION 157.466 FEET, CITY OF PORTLAND DATUM.
4. VERTICAL BOUNDARIES OF UNITS ARE FROM SURFACE OF UNFINISHED FLOORING TO UNFINISHED CEILING. HORIZONTAL BOUNDARIES OF UNITS ARE TO CENTER OF WALLS BETWEEN UNITS; INTERIOR FACE OF GLASS CURTAIN AND CONCRETE WALLS AND TO THE EXTERIOR FACE OF STUDS OR ALL OTHER WALLS.

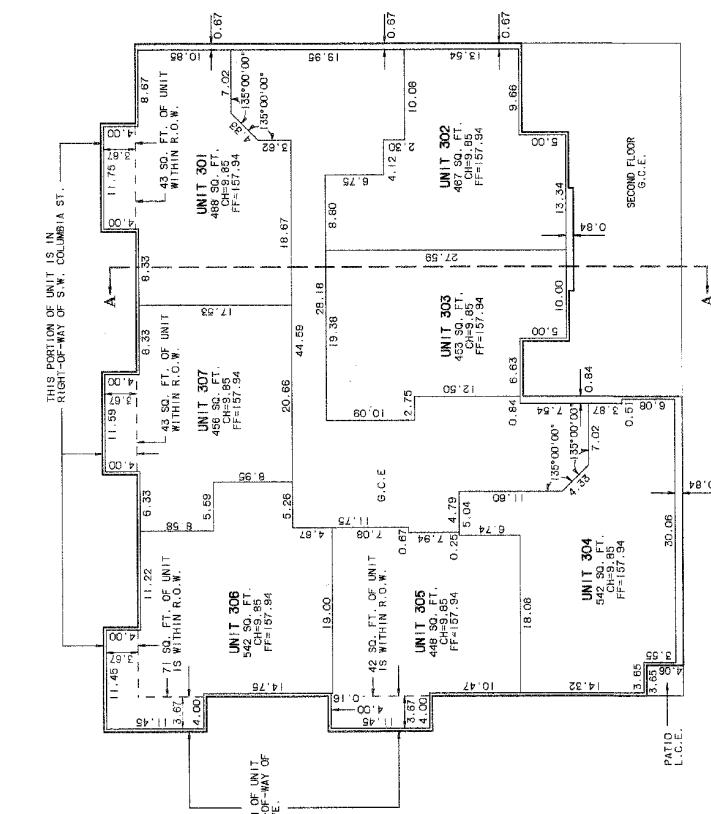

THIRD FLOOR

EXTERIOR WALLS ARE 0.33 WIDE UNLESS SHOWN OTHERWISE.

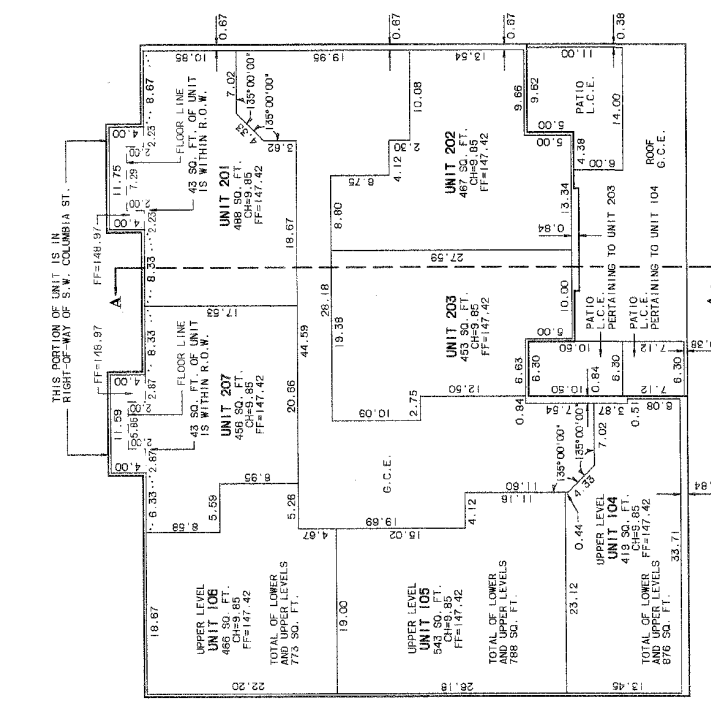

SECOND FLOOR

EXTERIOR WALLS ARE 0.33 WIDE UNLESS SHOWN OTHERWISE.

LEGEND

- FF FINISHED FLOOR ELEVATION
- CH CEILING HEIGHT
- SQ. FT. SQUARE FEET
- L.C.E. LIMITED COMMON ELEMENT
- G.C.E. GENERAL COMMON ELEMENT
- R.O.W. RIGHT-OF-WAY

REGISTERED PROFESSIONAL LAND SURVEYOR

R.L. Rohrer
OREGON
JULY 13, 1984
RANDY L. ROHRER
2107

I HEREBY CERTIFY THIS TO BE A TRUE AND EXACT COPY OF THE ORIGINAL PLAN

EXPIRES 12-31-04

I CERTIFY THAT THIS PLAN WAS PREPARED USING HEWLETT-PACKARD PRODUCT NO. 51645A ON CONTINENTAL JPCAM2 POLYESTER FILM.



W.B. WELLS AND ASSOCIATES, INC.
SURVEYORS/ENGINEERS/PLANNERS
4230 N.E. FREMONT STREET
PORTLAND, OREGON 97213
PHONE (503) 294-2830
FAX (503) 294-2830
FILE NO. 00-250 DTM

MOSAIC CONDOMINIUM

THE NORTHWESTERLY 75 FEET OF THE NORTHEASTERLY 1/4 FEET OF LOT 7 AND THE NORTHWESTERLY 55 FEET OF LOT 8, BLOCK 244, CITY OF PORTLAND, OREGON, SITUATED IN THE NORTHEAST QUARTER OF SECTION 4, TOWNSHIP 1 SOUTH, RANGE 1 EAST, WILLAMETTE MERIDIAN, CITY OF PORTLAND, MULTNOMAH COUNTY, STATE OF OREGON. MAY 13, 2003
SCALE: 1" = 10'

NOTES

1. BUILDING CORNERS ARE PERPENDICULAR, OR AS NOTED.
2. PATIOS ARE LIMITED COMMON ELEMENTS AND PERTAIN TO THE UNIT TO WHICH THEY ADJOIN.
3. FINISHED FLOOR ELEVATIONS ARE FROM CITY OF PORTLAND BENCHMARK NO. 2549, LOCATED AT THE SOUTHEAST CORNER OF THE INTERSECTION OF S.W. 12TH AVENUE AND S.W. CLAY STREET, ELEVATION 157.466 FEET, CITY OF PORTLAND DATUM.
4. VERTICAL BOUNDARIES OF UNITS ARE FROM SURFACE OF UNFINISHED FLOORING TO UNFINISHED CEILING. HORIZONTAL BOUNDARIES OF UNITS ARE TO CENTER OF WALLS BETWEEN UNITS, INTERIOR FACE OF GLASS OF PARTITION WALLS AND TO THE EXTERIOR FACE OF STUDS OF ALL OTHER WALLS.

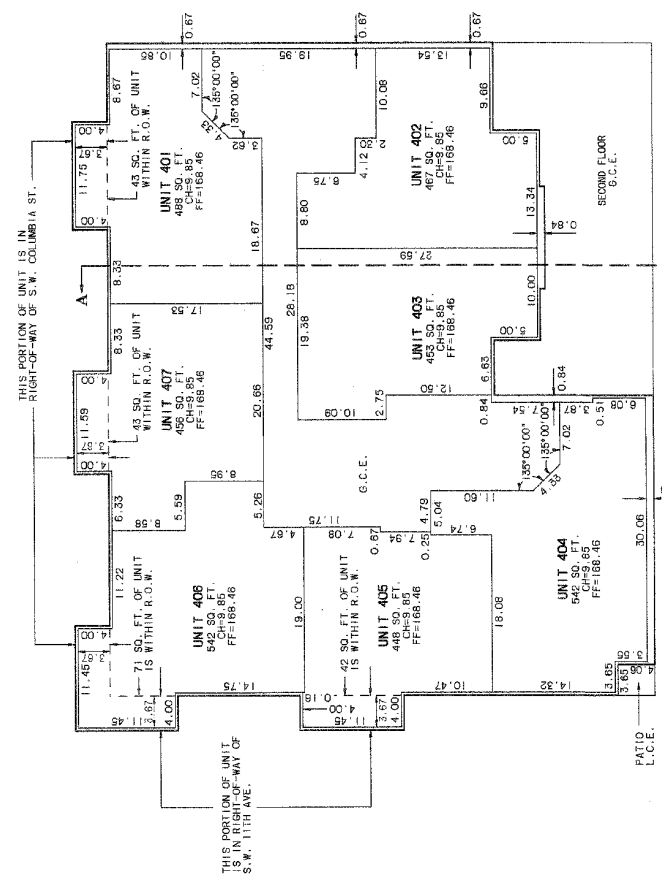

FOURTH FLOOR

EXTERIOR WALLS ARE 0.33 WIDE UNLESS SHOWN OTHERWISE.

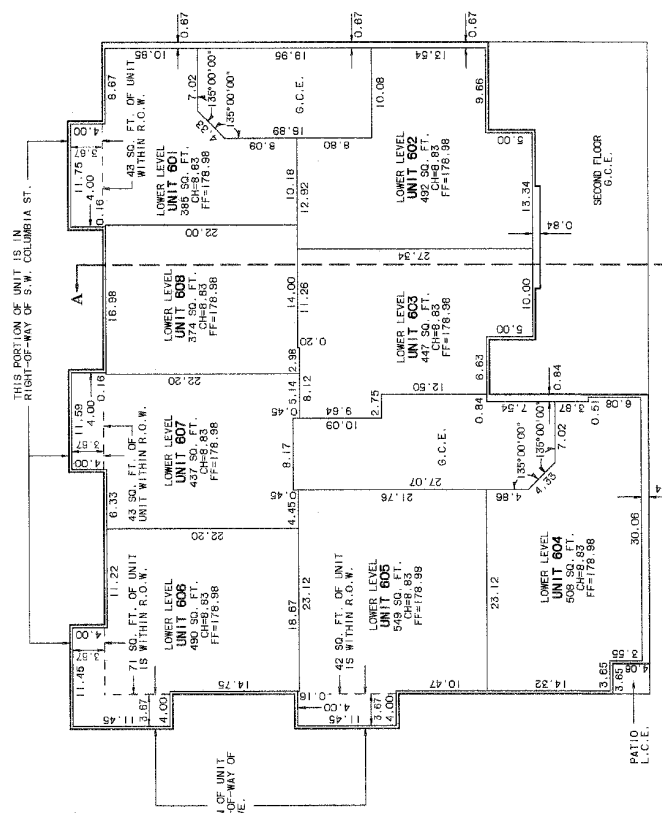

FIFTH FLOOR

EXTERIOR WALLS ARE 0.33 WIDE UNLESS SHOWN OTHERWISE.

LEGEND

- FF FINISHED FLOOR ELEVATION
- CH CEILING HEIGHT
- SD. FT. SQUARE FEET
- L.C.E. LIMITED COMMON ELEMENT
- G.C.E. GENERAL COMMON ELEMENT
- R.O.W. RIGHT-OF-WAY

REGISTERED PROFESSIONAL LAND SURVEYOR

R. L. ROHRER
OREGON
JULY 13, 1984
RANLY L. ROHRER
2107

I HEREBY CERTIFY THIS TO BE A TRUE AND EXACT COPY OF THE ORIGINAL PLAT

I CERTIFY THAT THIS PLAT WAS PREPARED USING HEWLETT-PACKARD PRODUCT NO. 51645A ON CONTINENTAL JFC4M2 POLYESTER FILM.
EXPIRES 12-31-84

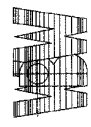

W. R. WELLS AND ASSOCIATES, INC.
SURVEYORS/ENGINEERS/PLANNERS
4230 N.E. FREMONT STREET
PORTLAND, OREGON 97213
PHONE (503) 284-9266
FAX (503) 284-9260
DTN (503) 284-9250
FILE NO. 00-250

MOSAIC CONDOMINIUM

THE NORTHEASTLY 75 FEET OF THE NORTHEASTLY 15 FEET OF LOT 7
 INTERESTEDLY 25 FEET OF LOT 8, BLOCK 242, CITY OF
 PORTLAND, SITUATED IN THE NORTHEAST QUARTER OF SECTION 4,
 TOWNSHIP 1 SOUTH, RANGE 1 EAST, WILLAMETTE MERIDIAN, CITY OF
 PORTLAND, MULTNOMAH COUNTY, STATE OF OREGON. MAY 13, 2003
 SCALE: 1" = 10'

NOTES

1. BUILDING CORNERS ARE PERPENDICULAR, OR AS NOTED.
2. PATIOS ARE LIMITED COMMON ELEMENTS AND PERTAIN TO THE UNIT TO WHICH THEY ADJOIN.
3. FINISHED FLOOR ELEVATIONS ARE FROM CITY OF PORTLAND BENCHMARK NO. 2549, LOCATED AT THE SOUTHEAST CORNER OF THE INTERSECTION OF S.W. 12TH AVENUE AND S.W. CLAY STREET. ELEVATION 137.466 FEET CITY OF PORTLAND DATUM.
4. VERTICAL BOUNDARIES OF UNITS ARE FROM SURFACE OF UNFINISHED FLOORING TO UNFINISHED CEILING. HORIZONTAL BOUNDARIES OF UNITS ARE TO CENTER OF WALLS BETWEEN UNITS. INTERIOR FACE OF GLASS CURTAIN AND OPERATE WALLS AND TO THE EXTERIOR FACE OF STUBS OF ALL OTHER WALLS.

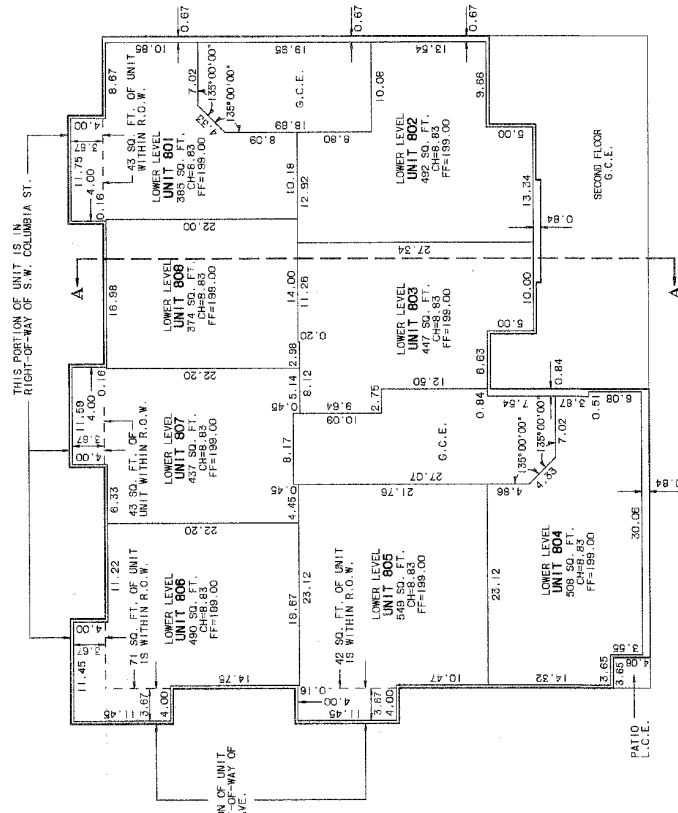

SEVENTH FLOOR

EXTERIOR WALLS ARE 0.33 WIDE UNLESS SHOWN OTHERWISE

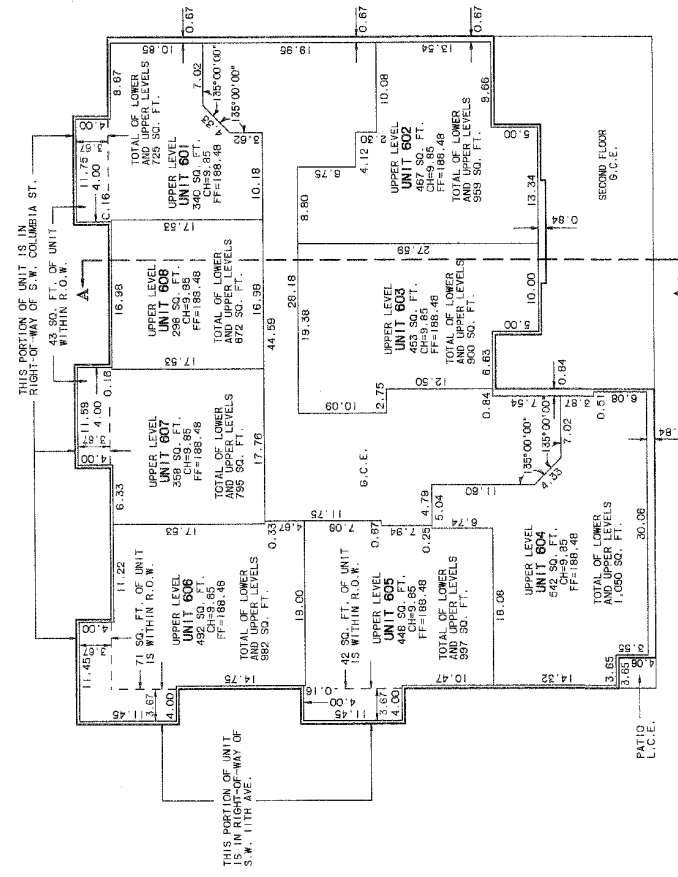

SIXTH FLOOR

EXTERIOR WALLS ARE 0.33 WIDE UNLESS SHOWN OTHERWISE

LEGEND

- FF FINISHED FLOOR ELEVATION
- CH CEILING HEIGHT
- SQ. FT. SQUARE FEET
- L.C.E. LIMITED COMMON ELEMENT
- G.C.E. GENERAL COMMON ELEMENT
- R.O.W. RIGHT-OF-WAY

REGISTERED PROFESSIONAL LAND SURVEYOR
R.L.R.
 OREGON
 JULY 13, 1994
 RANDY L. ROHMER
 2107

I HEREBY CERTIFY THIS IS TO BE A TRUE AND EXACT COPY OF THE ORIGINAL PLAT
 I CERTIFY THAT THIS PLAT WAS PREPARED USING HEWLETT-PACKARD PRODUCT NO. 51645A ON CONTINENTAL JPC4M2 POLYESTER FILM.
 EXPIRES 12-31-04

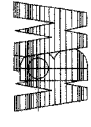

W.B. WELLS AND ASSOCIATES, INC.
 SURVEYORS/ENGINEERS/PLANNERS
 4230 N.E. FREEMONT STREET
 PORTLAND, OREGON 97213
 PHONE (503) 844-8630
 FAX (503) 284-8630
 FILE NO. 00-250 DTM

MOSAIC CONDOMINIUM

THE NORTHEASTERN 76 FEET OF THE NORTHEASTERN 15 FEET OF LOT 7 AND THE NORTHEASTERN 75 FEET OF LOT 8, BLOCK 244, CITY OF PORTLAND, SITUATED IN THE NORTHEAST QUARTER OF SECTION 4, TOWNSHIP 1 SOUTH, RANGE 1 EAST, WILLAMETTE MERIDIAN, CITY OF PORTLAND, MULTNOMAH COUNTY, STATE OF OREGON. MAY 13, 2003
SCALE: 1" = 10'

NOTES

1. BUILDING CORNERS ARE PERPENDICULAR, OR AS NOTED.
2. BALCONIES ARE LIMITED COMMON ELEMENTS AND PERTAIN TO THE UNIT TO WHICH THEY ADJOIN.
3. FINISHED FLOOR ELEVATIONS ARE FROM CITY OF PORTLAND BENCHMARK NO. 2549, LOCATED AT THE SOUTHEAST CORNER OF THE INTERSECTION OF S.W. 12TH AVENUE AND S.W. CLAY STREET, ELEVATION 157.466 FEET, CITY OF PORTLAND DATUM.
4. VERTICAL BOUNDARIES OF UNITS ARE FROM SURFACE OF UNFINISHED FLOORING TO UNFINISHED CEILING. HORIZONTAL BOUNDARIES OF UNITS ARE TO CENTER OF WALLS BETWEEN UNITS, INTERIOR FACE OF PARTITION AND CONCRETE WALLS AND TO THE EXTERIOR FACE OF STUBS OF ALL OTHER WALLS.

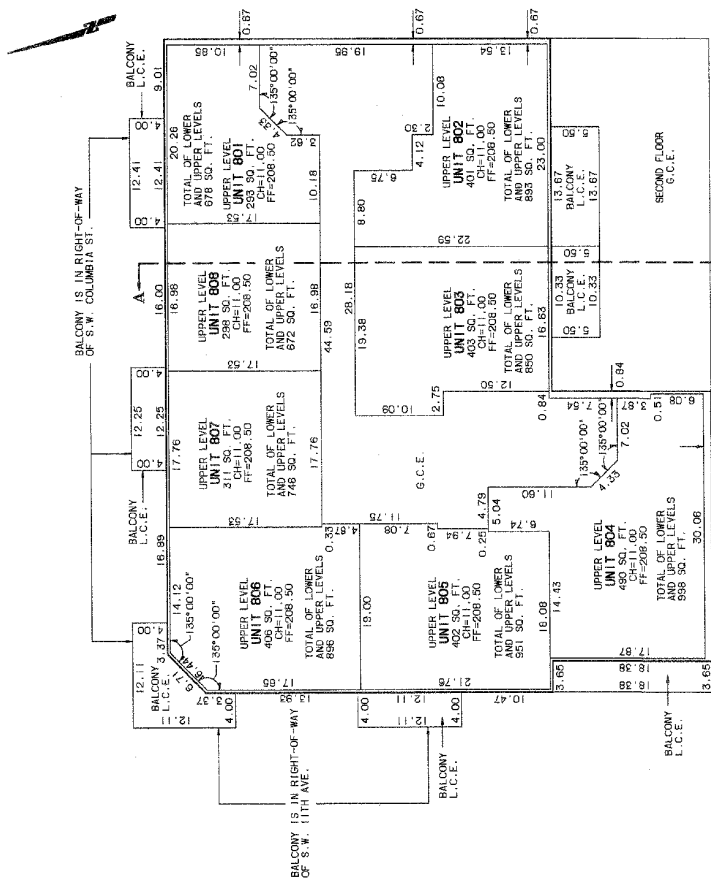

SECTION A-A

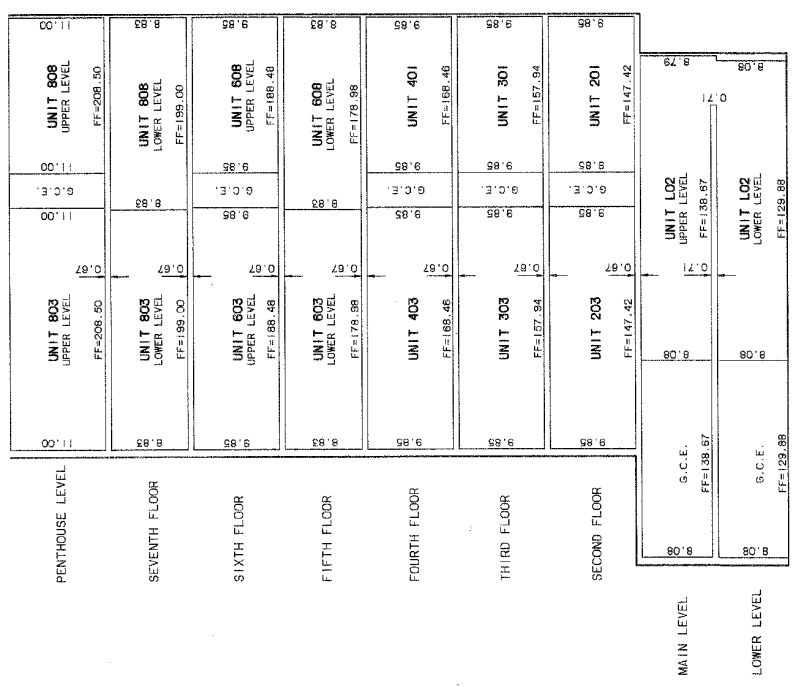

LEGEND

- FF FINISHED FLOOR ELEVATION
- CH CEILING HEIGHT
- SQ. FT. SQUARE FEET
- L.C.E. LIMITED COMMON ELEMENT
- G.C.E. GENERAL COMMON ELEMENT

REGISTERED PROFESSIONAL LAND SURVEYOR
R. L. ROSS
 OREGON
 JULY 13, 1984
 RANDY L. ROSS
 2187
 I HEREBY CERTIFY THIS TO BE A TRUE AND EXACT COPY OF THE ORIGINAL PLAT
 I CERTIFY THAT THIS PLAT WAS PREPARED USING HEWLETT-PACKARD PRODUCT NO. 516/65A ON CONTINENTAL JPC-M2 POLYESTER FILM.
 EXPIRES 12-31-84

W. B. WELLS AND ASSOCIATES, INC.
 SURVEYING ENGINEERS/PLANNERS
 4230 N.E. FREMONT STREET
 PORTLAND, OREGON 97213
 PHONE (503) 284-8830
 FAX (503) 284-8830
 FILE NO. 00-250 DTM PAGE 7 OF 8

MOSAIC CONDOMINIUM
 THE NORTHWESTERLY 75 FEET OF THE NORTHWESTERLY 1/4 SECTION 7 AND THE NORTHWESTERLY 75 FEET OF LOT 8, BLOCK 244, CITY OF PORTLAND, SITUATED IN THE NORTHEAST QUARTER OF SECTION 4, TOWNSHIP 1 SOUTH, RANGE 1 EAST, WILLAMETTE MERIDIAN, CITY OF PORTLAND, MULTNOMAH COUNTY, STATE OF OREGON, MAY 13, 2003

SURVEYOR'S CERTIFICATE

I, RANDY L. ROHNER, CERTIFY THAT I HAVE CORRECTLY SURVEYED AND PLATTED WITH PROPER MEASUREMENTS THE LAND REPRESENTED ON THE ANNEXED MAP OF "MOSAIC CONDOMINIUM", SAID LAND BEING DESCRIBED AS FOLLOWS:
 THE NORTHWESTERLY 75 FEET OF THE NORTHWESTERLY 1/4 SECTION 7 AND THE NORTHWESTERLY 75 FEET OF LOT 8, BLOCK 244, CITY OF PORTLAND, SITUATED IN THE NORTHEAST QUARTER OF SECTION 4, TOWNSHIP 1 SOUTH, RANGE 1 EAST, WILLAMETTE MERIDIAN, CITY OF PORTLAND, MULTNOMAH COUNTY, STATE OF OREGON, BEING MORE PARTICULARLY DESCRIBED AS FOLLOWS:

BEGINNING AT THE INITIAL POINT SAID POINT BEING THE NORTHWESTERLY CORNER OF SUBJECT TRACT, SAID POINT BEING MARKED BY A FOUND 9/8" IRON ROD WITH YELLOW PLASTIC CAP MARKED "W.B. WELLS & ASSOC. INC.", SAID POINT BEARS SOUTH 73°50'08" EAST, A DISTANCE OF 75.00 FEET FROM A FOUND BRASS SCREW WITH 3/4" BRASS WASHER MARKED "W.B. WELLS & ASSOC." MARKING THE NORTHWESTERLY CORNER OF THE NORTHWESTERLY 75.00 FEET OF SAID LOTS 7 AND 8, A DISTANCE OF 85.00 FEET TO THE MOST SOUTHERLY CORNER THEREOF; THENCE NORTH 73°50'08" WEST, ALONG THE SOUTHWESTERLY LINE OF THE NORTHWESTERLY 1/4 SECTION SAID LOT 7, A DISTANCE OF 75.00 FEET TO THE MOST WESTERLY CORNER SAID CORNER BEING THE NORTHWESTERLY CORNER OF SAID LOT 7; THENCE SOUTH 11°09'52" EAST, ALONG SAID SOUTHWESTERLY RIGHT-OF-WAY LINE AND THE NORTHWESTERLY LINE OF SAID LOTS 7 AND 8, A DISTANCE OF 85.00 FEET TO THE MOST NORTHERLY CORNER OF SAID LOT 8 SAID POINT BEING THE MOST SOUTHWESTERLY CORNER OF SAID LOT 8; THENCE ALONG SAID SOUTHWESTERLY RIGHT-OF-WAY LINE, AND THE NORTHWESTERLY LINE OF SAID LOT 8, A DISTANCE OF 75.00 FEET TO THE INITIAL POINT.

TOGETHER WITH THOSE PORTIONS OF BUILDINGS WITHIN THE STREET FRONTAGE OF SAID TRACT WHICH ARE SUBJECT TO THE UNIFORM BUILDING CODE WHICH PERMITS ORIENT (BAY) WINDOWS TO PROJECT UP TO 4 FEET INTO CONTAINING 4.875 SQUARE FEET.

CERTIFICATE OF COMPLETION

I, RANDY L. ROHNER, A REGISTERED PROFESSIONAL LAND SURVEYOR, DO HEREBY CERTIFY THAT THE WITHIN FLOOR PLANS OF "MOSAIC CONDOMINIUM" FULLY AND ACCURATELY DEPICT THE BOUNDARIES OF THE UNITS AND FLOORS OF "MOSAIC CONDOMINIUM" AND THAT THE IMPROVEMENTS THEREON DEPICTED ON THE FLOOR PLANS AND PLAT WERE COMPLETED AS OF OCTOBER 31, 2002.

I CERTIFY THAT THIS PLAT WAS PREPARED USING HEWLETT-PACKARD PRODUCT NO. 51645A ON CONTINENTAL JPC4M2 POLYESTER FILM.

REGISTERED PROFESSIONAL LAND SURVEYOR
R. L. Rohner
 OREGON
 JULY 13, 1984
 RANDY L. ROHNER
 2167
 EXPIRES 12-31-04

I HEREBY CERTIFY THIS TO BE A TRUE AND EXACT COPY OF THE ORIGINAL PLAT.

NARRATIVE

THE PURPOSE OF THIS SURVEY IS TO CREATE A CONDOMINIUM PLAT OF THE NORTHWESTERLY 75 FEET OF THE NORTHWESTERLY 1/4 SECTION 7 AND THE NORTHWESTERLY 75 FEET OF LOT 8, BLOCK 244, "CITY OF PORTLAND". THE BOUNDARY WAS HELD AS ESTABLISHED IN OUR PREVIOUS SURVEY FILED AS SN-31494, MULTNOMAH COUNTY SURVEY RECORDS.

DECLARATION

KNOW ALL PEOPLE BY THESE PRESENTS THAT MOSAIC PORTLAND CONDOMINIUM, LLC, AN OREGON LIMITED LIABILITY COMPANY, HEREBY DECLARES THE ANNEXED MAP OF "MOSAIC CONDOMINIUM", AS DESCRIBED IN THE ACCOMPANYING SURVEYOR'S CERTIFICATE, TO BE A TRUE AND CORRECT MAP AND PLAT HEREOF AND HEREBY COMITS SAID LAND TO THE USES AND PURPOSES OF THE CONDOMINIUM ACT AND THE PROVISIONS OF THE OREGON REVISED STATUTES, THE PROPERTY AND IMPROVEMENTS DESCRIBED AND DEPICTED ON THE PLAT ARE SUBJECT TO THE PROVISIONS OF OREGON REVISED STATUTES 100.005 TO 100.625.

MOSAIC PORTLAND CONDOMINIUM, LLC
 BY: A. Fraser McColl, PRESIDENT

ACKNOWLEDGEMENT

STATE OF OREGON)
 COUNTY OF MULTNOMAH)
 THE FOREGOING WAS ACKNOWLEDGED BEFORE ME THIS 24th DAY OF JUNE 2003, BY A. FRASER MCCOLL, PRESIDENT OF MOSAIC PORTLAND CONDOMINIUM, INC., AN OREGON CORPORATION, MEMBER OF MOSAIC PORTLAND CONDOMINIUM, LLC, AN OREGON LIMITED LIABILITY COMPANY, ON ITS BEHALF.

NOTARY SIGNATURE
James Christmas
 NOTARY PUBLIC - OREGON
 COMMISSION NO. 327005
 MY COMMISSION EXPIRES November 28, 2003

APPROVALS

APPROVED THIS 25th DAY OF June 2003
 COUNTY SURVEYOR, MULTNOMAH COUNTY, OREGON

BY: Robert A. Hatcher
 DEPUTY

ALL TAXES, FEES, ASSESSMENTS OR OTHER CHARGES AS PROVIDED BY DIRECTOR, DIVISION OF ASSESSMENT AND TAXATION
 MULTNOMAH COUNTY, OREGON
 BY: Jayama Stone
 DEPUTY

STATE OF OREGON)
 COUNTY OF MULTNOMAH)
 I DO HEREBY CERTIFY THAT THE ATTACHED CONDOMINIUM PLAT WAS RECEIVED FOR RECORD AND RECORDED

IN BOOK 1259, PAGES 3-10
 COUNTY RECORDING OFFICE, DEPUTY
 BY: D. M. [Signature]
 DOCUMENT NO. 2003-147824

W.B. WELLS AND ASSOCIATES, INC.
 SURVEYORS/ENGINEERS/PLANNERS
 4230 N.E. FREMONT STREET
 PORTLAND, OREGON 97213
 PHONE (503) 284-8630
 FAX (503) 284-8630
 FILE NO. 00-200
 PAGE 8 OF 8

AFTER RECORDING, RETURN TO:

Howard M. Feuerstein
Stoel Rives LLP *Plu 4-20-04*
900 SW Fifth Avenue
Portland, OR 97204

Recorded in MULTNOMAH COUNTY, OREGON
C. Swick, Deputy Clerk

G11 2 ATTDS
Total : 26.00

2004-067446 04/20/2004 03:42:47pm

**INSTRUMENT CORRECTING EXHIBIT C TO
DECLARATION SUBMITTING
MOSAIC CONDOMINIUM
TO CONDOMINIUM OWNERSHIP**

**THIS INSTRUMENT CORRECTING EXHIBIT C TO DECLARATION
SUBMITTING MOSAIC CONDOMINIUM TO CONDOMINIUM OWNERSHIP** (this
"Correction Instrument") is made this 20th day of April, 2004, by **MOSAIC PORTLAND
CONDOMINIUM, LLC**, an Oregon limited liability company ("Declarant").

RECITALS

A. Declarant recorded the Declaration Submitting Mosaic Condominium to Condominium Ownership on June 26, 2003 as Document No. 2003-147839 in the Real Property Records of Multnomah County, Oregon (the "Declaration").

B. The Declaration assigned Storage Space 28 to two units (L01 and 106) and failed to assign Storage Space 26. Storage Space 26 should have been assigned to Unit L01, and Storage Space 28 should only have been assigned to Unit 106.

C. This Correction Instrument is made for the sole purpose of assigning Storage Space 26 to Unit L01, in lieu of Storage Space 28, which shall continue to be assigned to Unit 106.

NOW, THEREFORE, the Declaration is hereby corrected as follows:

This Correction Instrument merely causes Exhibit C to reflect that Storage Space 26 is assigned to Unit L01 in lieu of Storage Space 28 and does not amend or change any provision in the text of the Declaration. As such, the Oregon Real Estate Commissioner concurs that this Correction Instrument does not constitute an amendment of the condominium declaration under the Oregon Condominium Act, and Declarant and the Association concur that it does not constitute an amendment to the Declaration under the terms of the Declaration. This Correction Instrument shall, to the extent possible, be deemed to be effective as of the date of the recordation of the Declaration.

Portlnd1-2154344.1 0040198-00001

J

4-20-04

IN WITNESS WHEREOF, Declarant has executed this Correction Instrument to be effective as of the date set forth above.

DECLARANT:

MOSAIC PORTLAND CONDOMINIUM, LLC,
an Oregon limited liability company

By: Mosaic Properties Oregon, Inc.

By: [Signature]
A. Fraser McColl, President

STATE OF OREGON)
)ss.
County of Multnomah)

The foregoing instrument was acknowledged before me this 20th day of April, 2004, by A. Fraser McColl, President of Mosaic Properties Oregon, Inc., Member of Mosaic Portland Condominium, LLC, an Oregon limited liability company, on its behalf.

[Signature]
Notary Public for Oregon
My commission expires: 3/11/05



4-20-04

AFTER RECORDING, RETURN TO:

Fidelity National
TRR

PREPARED BY:

Howard M. Feuerstein
Stoel Rives LLP
900 SW Fifth Avenue, Suite 2600
Portland, Oregon 97204

Recorded in MULTNOMAH COUNTY, OREGON
C. Swick, Deputy Clerk ATKLM
E41 53
Total : 279.00
2003-147839 06/26/2003 03:41:40pm

**DECLARATION SUBMITTING
MOSAIC CONDOMINIUM
TO CONDOMINIUM OWNERSHIP**

Mosaic Portland Condominium, LLC
Declarant

PortInd1-2116636-4 0040198-00002

53

6-26-03

TABLE OF CONTENTS

	Page
ARTICLE 1 DEFINITIONS.....	1
1.1 "Association"	1
1.2 "Bylaws"	1
1.3 "Condominium"	1
1.4 "Declarant"	1
1.5 "Declaration"	1
1.6 "Eligible Mortgage Insurer or Guarantor"	1
1.7 "Eligible Mortgage Holder"	1
1.8 "Mortgage" and "Mortgagee"	1
1.9 "Plat"	2
1.10 Incorporation by Reference.....	2
ARTICLE 2 SUBMISSION OF PROPERTY TO CONDOMINIUM STATUTE.....	2
ARTICLE 3 NAME OF CONDOMINIUM.....	2
ARTICLE 4 UNITS.....	2
4.1 General Description of Buildings.	2
4.2 General Description, Location and Designation of Units.....	2
4.3 Boundaries of Units.	2
ARTICLE 5 GENERAL COMMON ELEMENTS.....	3
ARTICLE 6 LIMITED COMMON ELEMENTS.....	3
ARTICLE 7 ALLOCATION OF UNDIVIDED INTERESTS IN COMMON ELEMENTS.....	3
ARTICLE 8 COMMON PROFITS AND EXPENSES; VOTING	4
8.1 Allocation of Common Profits and Expenses.....	4
8.2 Allocation of Voting Rights.....	4
ARTICLE 9 SERVICE OF PROCESS.....	4
ARTICLE 10 USE OF PROPERTY	4
ARTICLE 11 MAINTENANCE OF COMMON ELEMENTS.....	4
11.1 Responsibility for Maintenance.	4
11.2 Mortgagee's Rights upon Failure to Maintain.....	5
11.3 Rights of City Upon Failure to Maintain.	5

6-26-03

ARTICLE 12 EASEMENTS	5
12.1 In General.....	5
12.2 Encroachments.....	5
12.3 Granting of Easements by Association.....	6
12.4 Right of Entry.....	6
12.5 Easements for Declarant.....	6
ARTICLE 13 APPROVAL BY MORTGAGEES.....	6
13.1 Notice of Action.....	6
13.2 Termination and Amendment to Documents.....	7
13.3 Additional Approvals.....	8
13.4 Notice to First Mortgagees of Defaults.....	8
ARTICLE 14 ASSOCIATION OF UNIT OWNERS	9
14.1 Organization.....	9
14.2 Membership; Board of Directors.....	9
14.3 Powers and Duties.....	9
14.4 Adoption of Bylaws, Declarant Control of Association.....	9
ARTICLE 15 AMENDMENT.....	9
15.1 How Proposed.....	9
15.2 Approval Required.....	9
15.3 Recordation.....	10
ARTICLE 16 SEVERABILITY	10
ARTICLE 17 APPLICABILITY	10

6-26-03

**DECLARATION SUBMITTING
MOSAIC CONDOMINIUM
TO CONDOMINIUM OWNERSHIP**

THIS DECLARATION, pursuant to the provisions of the Oregon Condominium Act, is made and executed this 13th day of May, 2003, by **MOSAIC PORTLAND CONDOMINIUM, LLC**, an Oregon limited liability company ("**Declarant**").

Declarant proposes to create a condominium to be known as Mosaic Condominium, which will be located in the City of Portland, Multnomah County, Oregon. The purpose of this Declaration is to submit the property described in Article 2 below to the condominium form of ownership and use in the manner provided by the Oregon Condominium Act.

NOW, THEREFORE, Declarant does hereby declare and provide as follows:

Article 1

Definitions

When used in this Declaration the following terms shall have the following meanings:

1.1 "**Association**" means the association of unit owners established pursuant to Article 14 below.

1.2 "**Bylaws**" means the Bylaws of the Mosaic Condominium Association adopted pursuant to Section 14.4 below as the same may be amended from time to time.

1.3 "**Condominium**" means all of that property submitted to the condominium form of ownership by this Declaration.

1.4 "**Declarant**" means Mosaic Portland Condominium, LLC, an Oregon limited liability company, and its successors and assigns.

1.5 "**Declaration**" means this Declaration as the same may hereafter be amended.

1.6 "**Eligible Mortgage Insurer or Guarantor**" means an insurer or governmental guarantor of a first mortgage on a unit who has requested notice of certain matters from the Association in accordance with Section 13.1 below.

1.7 "**Eligible Mortgage Holder**" means a holder of a first mortgage on a unit who has requested notice of certain matters from the Association in accordance with Section 13.1 below, but shall not include a contract vendor.

1.8 "**Mortgage**" and "**Mortgagee**" mean, respectively, a recorded mortgage, trust deed or contract of sale which creates a lien against a unit, and the holder, beneficiary or vendor of such a mortgage, trust deed or contract of sale.

PortInd1-2116636.4 0040198-00002

6-26-03

1.9 **"Plat"** means the plat of Mosaic Condominium recorded simultaneously with the recording of this Declaration.

1.10 **Incorporation by Reference.** Except as otherwise provided in this Declaration, each of the terms defined in ORS 100.005, a part of the Oregon Condominium Act, shall have the meanings set forth in such section.

Article 2

Submission of Property to Condominium Statute

The property submitted to the Oregon Condominium Act by this Declaration is held by Declarant and conveyed by Declarant in fee simple estate. The land submitted is located in the City of Portland, Multnomah County, Oregon, and is more particularly described in the attached **Exhibit A.** The property submitted includes the land so described, all buildings, improvements and structures, all easements, and rights and appurtenances located on, belonging to or used in connection with such land.

Article 3

Name of Condominium

The name by which the Condominium shall be known is "Mosaic Condominium."

Article 4

Units

4.1 **General Description of Buildings.** The Condominium contains one building of dwelling units having nine stories, without basement. The building is of concrete construction with glass facade and a reinforced hot applied membrane roof.

4.2 **General Description, Location and Designation of Units.** The Condominium consists of 40 units. The designation, location, description of boundaries and area in square feet of each unit are shown on the Plat and the attached **Exhibit B.**

4.3 **Boundaries of Units.** Each unit shall be bounded by (i) a vertical plane at the center of the air space within the walls between adjoining units; (ii) the interior surface of the glass curtain wall; (iii) for other walls, a vertical plane at the exterior face of the studs, except for concrete walls, for which the boundary is the unfinished interior face of the concrete surface; (iv) the exterior surface of doors and door frames and trim; (v) the interior surface of unfinished flooring; and (vi) the interior surface of ceilings. The unit shall include all lath, furring, wallboard, plasterboard, plaster, paneling, tiles, wallpaper, paint, finished flooring and any other material constituting any part of its finished surfaces, except those portions of the walls, floors or ceilings that materially contribute to the structural or shear capacity of the Condominium. In

PortInd1-2116636.4 0040198-00002

addition, each unit shall include the following: (a) all spaces, nonbearing interior partitions, windows, window frames, exterior doors, door frames and all other fixtures and improvements within the boundaries of the unit; and (b) all outlets of utility and communications service lines, including but not limited to power, light, gas, hot and cold water, heating, refrigeration, air conditioning and waste disposal, security, cable television and telephone, within the boundaries of the unit, but shall not include any part of such lines or ducts themselves.

Article 5

General Common Elements

The general common elements consist of all portions of the Condominium that are not part of a unit or a limited common element, including, but not limited to, the following:

5.1 The land, pathways, fences and grounds.

5.2 Pipes, ducts, flues, chutes, conduits, wires and other utility and communications installations to their outlets.

5.3 Roofs, foundations, bearing and shear walls, perimeter walls, the glass curtain wall, beams, columns and girders to the interior surfaces thereof.

5.4 Stairways, landings, hallways, lobby, elevator, entrances and exits which are not part of a unit.

5.5 All other elements of the buildings and the Condominium necessary or convenient to their existence, maintenance and safety, or normally in common use, except as may be expressly designated in this Declaration as part of a unit or a limited common element.

Article 6

Limited Common Elements

The following shall constitute limited common elements, the use of which shall be restricted to the units to which they pertain:

6.1 All entries, patios and balconies marked as limited common elements on the Plat, each of which shall pertain to the unit which it adjoins as shown on the Plat.

6.2 Storage spaces designated as limited common elements in the Plat, each of which shall pertain to the unit indicated in the attached Exhibit C.

Article 7

Allocation of Undivided Interests in Common Elements

Each unit will be entitled to an undivided ownership interest in the common elements determined by the ratio by which the approximate area of the particular unit bears to the total

PortInd1-2116636.4 0040198-00002

6-26-03

approximate area of all units combined, as shown on the attached Exhibit B. Each unit's interest in the common elements shall be inseparable from the unit and any conveyance, encumbrance, judicial sale, or other transfer, voluntary or involuntary, of an undivided interest in the common elements shall be void unless the unit to which that interest is allocated is also transferred.

Article 8

Common Profits And Expenses; Voting

8.1 Allocation of Common Profits and Expenses. The common profits and common expenses of the Condominium shall be allocated to the owner of each unit according to the allocation of undivided interest of such unit in the common elements. Except upon termination of the Condominium or as otherwise provided in the Bylaws with respect to damage, destruction or condemnation, any such common profits shall be used solely for the purpose of maintaining, repairing and replacing the common elements or for other expenses or reserves of the Association.

8.2 Allocation of Voting Rights. Each unit owner shall be entitled to one vote in the affairs of the Association and for the purposes of this Declaration for each unit owned by such owner. The method of voting shall be as specified in the Bylaws.

Article 9

Service Of Process

The designated agent to receive service of process in cases provided in subsection (1) of ORS 100.550 is named in the Condominium Information Report which has been filed in accordance with ORS 100.250(1)(a).

Article 10

Use of Property

Each unit is to be used for residential purposes as described in the Bylaws. Units L01, 104, 105 and 106 may be used for residential or for retail, commercial, office, professional or studio purposes to the extent permitted by applicable land use regulations. Additional limitations on use are contained in the Bylaws and the rules and regulations adopted pursuant to the Bylaws. Each unit owner shall be bound by each of such documents.

Article 11

Maintenance of Common Elements

11.1 Responsibility for Maintenance. The necessary work to maintain, repair or replace the common elements shall be the responsibility of the board of directors of the Association and shall be carried out as provided in the Bylaws.

11.2 **Mortgagee's Rights upon Failure to Maintain.** If the mortgagee of any unit determines that the board of directors is not providing an adequate maintenance, repair and replacement program for the common elements, such mortgagee, at its option, may give a notice to the board of directors by delivering same to the registered agent, setting forth the particular defect which it believes exists in the maintenance, repair and replacement program. If the specified defects are not corrected within 90 days subsequent to receipt of such notice, then the mortgagee, upon written notice to the registered agent that it is exercising its proxy rights, shall have the right to attend succeeding annual or special meetings of the Association and to cast a vote for each unit on which it holds a mortgage on all business coming before such meeting. Such proxy rights shall continue until the defects listed on the notice are corrected.

11.3 **Rights of City Upon Failure to Maintain.** The provisions of this Declaration and of the Bylaws regarding the maintenance, repair and replacement of the common elements shall be deemed to be for the benefit of the City of Portland, as well as the unit owners, and the City may enforce such provisions by appropriate proceedings at law or in equity. Without limitation to the foregoing, the City may deliver a written notice to the board of directors by delivering the same to the registered agent, setting forth the particular defect which it believes exists in the maintenance, repair and replacement program. If the specified defects are not corrected within 30 days after receipt of the notice, or, if such correction cannot reasonably be completed within such time, the Association fails within such time to commence and pursue the correction with reasonable diligence, then the City may take necessary curative action. In such event, the cost of correction by the City shall constitute a lien against each unit and its interest in the common elements based upon such unit's share of the common expenses as provided in this Declaration.

Article 12

Easements

12.1 **In General.** Each unit has an easement in and through each other unit and the common elements for all support elements and utility, wiring, heat, plumbing, and service elements, and for reasonable access thereto, as required to effectuate and continue proper operation of the Condominium, including, without limitation, an easement for Unit L06's air-conditioning compressor to be in the general common elements. In addition, each unit and all the common elements are specifically subject to easements as required for the electrical wiring and plumbing for each unit. The specific mention or reservation of any easement in this Declaration does not limit or negate the general easement for common elements reserved by law. Each unit owner has an unrestricted right of ingress and egress to his or her unit. This right is perpetual and passes with the ownership of the unit.

12.2 **Encroachments.** Each unit and all common elements shall have an easement over all adjoining units and common elements for the purpose of accommodating any present or future encroachment as a result of engineering errors, construction, reconstruction, repairs, settlement, shifting, or movement of any portion of the property, or any other similar cause, and any encroachment due to building overhang or projection as long as the physical boundaries of the units are in substantial accord with the description of those boundaries that appears in the Declaration. There shall be valid easements for the maintenance of the encroaching units and

PortInd1-2116636.4 0040198-00002

common elements so long as the encroachments shall exist, and the rights and obligations of owners shall not be altered in any way by the encroachment. This provision does not relieve a unit owner of liability in the case of willful misconduct of the unit owner, or relieve Declarant or any contractor, subcontractor or materialman from any liability as a result of failure to adhere to the Plat. The encroachments described in this Section 12.2 shall not be construed to be encumbrances affecting the marketability of title to any unit.

12.3 **Granting of Easements by Association.** Pursuant to ORS 100.405(5), the Association, upon prior approval of 75 percent of the voting power of the unit owners, may grant, execute, acknowledge, deliver and record on behalf of the unit owners leases, easements, rights-of-way, licenses, and similar interests in excess of two years affecting the common elements and consent to vacation of roadways within and adjacent to the Condominium. Any such instrument shall be executed by the chairperson and secretary of the Association. No such interest may be granted with regard to a limited common element unless the owners and mortgagees of the units having the right to use such limited common element consent to and join in the instrument granting the interest.

12.4 **Right of Entry.** The board of directors of the Association, managing agent, manager or any other person authorized by the board of directors shall have the right to enter any unit and limited common element in the case of an emergency originating in or threatening such unit or other condominium property, whether or not the owner is present at the time. Such persons shall also have the right to enter any unit and limited common element for the purpose of performing installations, alterations or repairs to any common element and for the purpose of inspection to verify that the unit owner is complying with the restrictions and requirements described in this Declaration and the Bylaws, provided that requests for entry are made in advance and that such entry is at a time convenient to the owner.

12.5 **Easements for Declarant.** Declarant and Declarant's agents, successors and assigns shall have an easement over and upon the common elements as may be reasonably necessary for the purpose of completing or making repairs to existing structures, for the purpose of carrying out sales and rental activities necessary or convenient for the sale or rental of units, including, without limitation, the right to use the units owned by Declarant as model units and the right to use a unit as a sales office, and for the purpose of discharging any other obligation of Declarant or exercising any other special Declarant right, whether arising under the Oregon Condominium Act or reserved in this Declaration or the Bylaws.

Article 13

Approval by Mortgagees

13.1 **Notice of Action.** Upon written request to the Association identifying the name and address of the holder, insurer or guarantor and the unit number or address of the unit on which it has (or insures or guarantees) the mortgage, any such eligible mortgage holder or eligible insurer or guarantor shall be entitled to timely written notice of the following:

(a) Any condemnation or casualty loss which affects a material portion of the Condominium or affects the unit securing its mortgage.

PortInd1-2116636.4 0040198-00002

(b) Any 60-day delinquency in the payment of assessments or charges owed by an owner of any unit on which it holds the mortgage.

(c) Any lapse, cancellation or material modification of any insurance policy maintained by the Association.

(d) Any proposed action which would require consent of a specified percentage of eligible mortgage holders as required by this article.

13.2 Termination and Amendment to Documents.

(a) The approval of eligible holders holding mortgages on units which have at least 67 percent of the voting rights of units subject to eligible holder mortgages shall be required to terminate the legal status of the project as a condominium for reasons other than substantial destruction or condemnation of the property.

(b) Except when a greater percent is required by the Declaration or Bylaws, or a greater or lesser percent is required by the Oregon Condominium Act, the consent of the owners of units holding at least 67 percent of the voting rights and the approval of eligible holders holding mortgages on units which have at least 51 percent of the voting rights of the units subject to eligible holder mortgages shall be required for any amendments of a material nature to the Declaration or Bylaws. Any amendment to the Declaration or Bylaws which changes any of the following shall constitute a material change:

- (1) Voting rights;
- (2) Increases in assessments that raise the previously assessed amount by more than twenty-five percent (25%), assessment liens or the priority of such liens;
- (3) Reduction in reserves for maintenance, repair and replacement of the common elements;
- (4) Responsibility for maintenance and repairs;
- (5) Reallocation of interests in the general or limited common elements, or rights to their use;
- (6) The boundaries of any unit;
- (7) Convertibility of units into common elements or of common elements into units;
- (8) Expansion or contraction of the Condominium or the addition, annexation or withdrawal of property to or from the Condominium;
- (9) Hazard or fidelity insurance requirements;
- (10) Imposition of any restrictions on the leasing of units;

6-26-03

(11) Imposition of any restriction on the right of a unit owner to sell or transfer his or her unit;

(12) Restoration or repair of the Condominium (after damage or partial condemnation) in a manner other than specified in this Declaration or the Bylaws;

(13) Any action to terminate the legal status of the Condominium after substantial destruction or condemnation occurs; or

(14) Any provisions that expressly benefit mortgage holders, insurers or guarantors.

(c) An addition or amendment to the Declaration or Bylaws shall not be considered material for purposes of Section 13.2(b) if it is for the purpose of correcting technical errors, or for clarification only. Any eligible mortgage holder who receives a written request to approve any termination, additions or amendments and who does not deliver or post to the requesting party a negative response within 30 days shall after it receives proper notice of the proposal, provided the notice was delivered by certified or registered mail, return receipt requested, be deemed to have approved such request.

13.3 **Additional Approvals.** In addition to any other approvals required by the Oregon Condominium Act, this Declaration or the Bylaws, the prior written approval of two-thirds of the holders of first mortgages on units in the Condominium (based upon one vote for each first mortgage owned) or unit owners (other than Declarant) must be obtained for the following:

(a) Abandonment or termination of the Condominium regime.

(b) Any change in the pro rata interest or obligations of any individual unit for (a) purpose of levying assessments or charges or allocating distributions of hazard insurance proceeds or condemnation awards, or (b) determining the pro rata share of ownership of each unit in the common elements.

(c) The partition or subdivision of any unit.

(d) Abandonment, partition, subdivision, encumbrance, sale or transfer of the common elements. The granting of easements for public utilities or for other public purposes consistent with the intended use of the common elements by the condominium project shall not be deemed a transfer within the meaning of this clause.

(e) Use of hazard insurance proceeds for losses to any condominium property, whether to units or to common elements, for other than the repair, replacement or reconstruction of such improvements, except as provided by statute in cases of substantial loss to the units and/or common elements of the condominium project.

13.4 **Notice to First Mortgagees of Defaults.** Any first mortgagee, upon request, will be entitled to written notification from the Association of any default in the performance by the

owner of the mortgaged unit of any obligation under this Declaration, the rules and regulations or the Bylaws which is not cured within 60 days.

Article 14

Association of Unit Owners

14.1 **Organization.** Upon the recording of this Declaration an association of unit owners shall be organized to serve as a means through which the unit owners may take action with regard to the administration, management and operation of the Condominium. The name of this association shall be "Mosaic Condominium Association," and the Association shall be an Oregon nonprofit corporation.

14.2 **Membership; Board of Directors.** Each unit owner shall be a member of the Association. The affairs of the Association shall be governed by a board of directors as provided in the Bylaws.

14.3 **Powers and Duties.** The Association shall have such powers and duties as may be granted to it by the Oregon Condominium Act, including each of the powers set forth in ORS 100.405(4), together with such additional powers and duties afforded it by this Declaration or the Bylaws.

14.4 **Adoption of Bylaws, Declarant Control of Association.** Upon the execution and the recording of this Declaration, Declarant shall adopt Bylaws for the Association, which Bylaws are attached as Exhibit D. Declarant specifically reserves the right to control the Association by appointing the interim directors of the Association until the organizational and turnover meeting of the Association has been held and the unit owners have elected regular directors as provided in Sections 2.2 and 3.4 of the Bylaws. In addition, Declarant shall have the right to consent to any amendment to the Declaration or the Bylaws as provided in Section 15.2 below and Section 9.2 of the Bylaws.

Article 15

Amendment

15.1 **How Proposed.** Amendments to the Declaration shall be proposed by either a majority of the board of directors or by unit owners holding thirty percent (30%) or more of the voting rights. The proposed amendment must be reduced to writing and shall be included in the notice of any meeting at which action is to be taken thereon or attached to any request for consent to the amendment.

15.2 **Approval Required.** Except as may otherwise be provided in this Declaration or by the Oregon Condominium Act, this Declaration may be amended if such amendment is approved by unit owners holding 75 percent of the voting rights of the Condominium and by mortgagees to the extent required by Article 13. Declarant's prior written consent shall also be required so long as Declarant owns 25 percent or more of the units in the Condominium, but no such consent shall be required after three years from the date of conveyance of the first unit to a

person other than Declarant. Except as otherwise permitted by the Oregon Condominium Act, no amendment may change the size, location, allocation of undivided interest in the common elements, method of determining liability for common expenses, right to common profits, or voting rights of any unit unless such amendment has been approved by the owners and mortgagees of the affected unit. Any amendment which would limit or diminish any special Declarant rights established in this Declaration or the Bylaws shall require the written consent of Declarant.

15.3 **Recordation.** The amendment shall be effective upon recordation in the Deed Records of Multnomah County, Oregon, of the Declaration as amended or of the amendment thereto, certified to by the chairperson and secretary of the Association as being adopted in accordance with this Declaration and the provisions of the Oregon Condominium Act, and approved by the county assessor and the Real Estate Commissioner if such approvals are required by the Oregon Condominium Act.

Article 16

Severability

Each provision of this Declaration and the Bylaws shall be deemed independent and severable, and the validity or partial invalidity of any provision shall not affect the validity or enforceability of the remaining part of that or any other provision of this Declaration or the Bylaws.

Article 17

Applicability

Each unit owner, including Declarant as to any unsold unit, shall be subject to all of the rights and duties assigned to unit owners under the terms of the Declaration and Bylaws.

IN WITNESS WHEREOF, Declarant has caused this Declaration to be executed as of the day and year first set forth above.

MOSAIC PORTLAND CONDOMINIUM, LLC,
an Oregon limited liability company

By: Mosaic Properties Oregon, Inc.

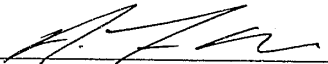
By 
A. Fraser McColl, President

6-26-03

STATE OF OREGON)
County of Multnomah) ss.

The foregoing instrument was acknowledged before me this 13th day of May, 2003, by A. Fraser McColl, President of Mosaic Properties Oregon, Inc., an Oregon corporation, member of Mosaic Portland Condominium, LLC, an Oregon limited liability company, on its behalf.



Patricia A. Kester
Notary Public for Oregon
My commission expires: 3/11/05
Commission No.: 343386

The foregoing Declaration is approved this 26th day of June, 2003.

**ASSESSOR AND TAX COLLECTOR
FOR MULTNOMAH COUNTY**

By [Signature]

The foregoing Declaration is approved pursuant to ORS 100.110 this 3 day of June, 2003 and in accordance with ORS 100.110(7), this approval shall automatically expire if this Declaration is not recorded within two (2) years from this date.

SCOTT W. TAYLOR,
Real Estate Commissioner

By [Signature]
Brian DeMarco

6-26-03

EXHIBIT A

Legal Description

The real property being described as follows:

The Northwesterly 75 feet of the Northeasterly 15 feet of Lot 7 and the Northwesterly 75 feet of Lot 8, Block 244, "City of Portland," situated in the Northeast Quarter of Section 4, Township 1 South, Range 1 East, Willamette Meridian, City of Portland, Multnomah County, State of Oregon, being more particularly described as follows:

Beginning at the initial point, said point being the Northeasterly corner of subject tract, said point being marked by a found 5/8" iron rod with yellow plastic cap marked "W.B. Wells & Assoc. Inc.," said point bears South 73°50'08" East, a distance of 75.00 feet from a found brass screw with 3/4" brass washer marked "W.B. Wells & Assoc.," marking the Northwesterly corner of said Lot 8; thence South 16°09'52" West, along the Southeasterly line of the Northwesterly 75.00 feet of said Lots 7 and 8, a distance of 65.00 feet to the most southerly corner thereof; thence North 73°50'08" West, along the Southwesterly line of the Northeasterly 15 feet of said Lot 7, a distance of 75.00 feet to the most westerly corner thereof, said point being on the Southeasterly right-of-way line SW 11th Avenue and the Northwesterly line of said Lot 7; thence North 16°09'52" East, along said Southeasterly right-of-way line and the Northwesterly line of said Lots 7 and 8, a distance of 65.00 feet to the most Northerly corner of said Lot 8, said point being on the Southwesterly right-of-way line of SW Columbia Street; thence South 73°50'08" East, along said Southwesterly right-of-way line, and the Northeasterly line of said Lot 8, a distance of 75.00 feet to the Initial Point.

6-26-03

EXHIBIT B

Unit Square Footages and Undivided Interests

Unit	Square Footage	Undivided Interest
L01	870	870/27227
L02	834	834/27227
L03	664	664/27227
104	876	876/27227
105	788	788/27227
106	773	773/27227
201	488	488/27227
202	467	467/27227
203	453	453/27227
207	456	456/27227
301	488	488/27227
302	467	467/27227
303	453	453/27227
304	542	542/27227
305	448	448/27227
306	542	542/27227
307	456	456/27227
401	488	488/27227
402	467	467/27227
403	453	453/27227
404	542	542/27227
405	448	448/27227
406	542	542/27227
407	456	456/27227
601	725	725/27227
602	959	959/27227
603	900	900/27227
604	1050	1050/27227
605	997	997/27227
606	982	982/27227
607	795	795/27227
608	672	672/27227
801	678	678/27227
802	893	893/27227
803	850	850/27227
804	998	998/27227
805	951	951/27227
806	896	896/27227
807	748	748/27227
808	672	672/27227
TOTALS	27227	1

6-26-03

EXHIBIT C

Storage Space Assignments

<u>Unit</u>	<u>Storage Space</u>
L01	28
L02	29
L03	27
104	30
105	11
106	28
201	1
202	2
203	3
207	4
301	5
302	6
303	7
304	8
305	9
306	10
307	19
401	18
402	17
403	16
404	15
405	14
406	13
407	12
601	25
602	24
603	23
604	20
605	21
606	22
607	40
608	39
801	31
802	32
803	33
804	34
805	35
806	36
807	37
808	38

PortInd1-2116636.4 0040198-00002

6-26-03

EXHIBIT D

BYLAWS
OF
MOSAIC CONDOMINIUM ASSOCIATION

PortInd1-2116690.3 0040198-00002

6-26-03

TABLE OF CONTENTS

	Page
ARTICLE 1 PLAN OF CONDOMINIUM OWNERSHIP	1
1.1 Name and Location.....	1
1.2 Principal Office.....	1
1.3 Purposes.....	1
1.4 Applicability of Bylaws.....	1
1.5 Composition of Association.....	1
1.6 Incorporation.....	1
1.7 Definitions.....	1
ARTICLE 2 MEETINGS OF ASSOCIATION.....	2
2.1 Place of Meetings.....	2
2.2 Organizational and Turnover Meeting.....	2
2.3 Annual Meetings.....	2
2.4 Special Meetings.....	2
2.5 Notice of Meetings.....	2
2.6 Voting.....	2
2.7 Absentee Ballots and Proxies.....	3
2.8 Fiduciaries and Joint Owners.....	3
2.9 Tenants and Contract Vendors.....	3
2.10 Quorum of Unit Owners.....	3
2.11 Majority Vote.....	3
2.12 Order of Business.....	4
2.13 Rules of Order.....	4
2.14 Ballot Meetings.....	4
ARTICLE 3 BOARD OF DIRECTORS	5
3.1 Number and Qualification.....	5
3.2 Interim Directors.....	5
3.3 Transitional Committee.....	5
3.4 Election and Term of Office.....	6
3.5 Vacancies.....	6

6-26-03

3.6	Removal of Directors.....	6
3.7	Powers and Duties.....	6
3.8	Managing Agent or Manager.....	8
3.9	Contracts Entered into by Declarant or Interim Board.....	8
3.10	Organizational Meeting.....	9
3.11	Regular and Special Meetings.....	9
3.12	Open Meetings.....	9
3.13	Waiver of Notice.....	9
3.14	Quorum of Board of Directors.....	9
3.15	Compensation.....	10
3.16	Liability and Indemnification of Directors, Officers and Managing Agent.....	10
3.17	Insurance.....	10
ARTICLE 4 OFFICERS.....		11
4.1	Designation.....	11
4.2	Election of Officers.....	11
4.3	Removal of Officers.....	11
4.4	Chairperson.....	11
4.5	Secretary.....	11
4.6	Treasurer.....	11
4.7	Execution of Instruments.....	12
4.8	Compensation of Officers.....	12
ARTICLE 5 BUDGET, EXPENSES AND ASSESSMENTS.....		12
5.1	Budget.....	12
5.2	Determination of Common Expenses.....	12
5.3	Assessment of Common Expenses.....	13
5.4	Special or Extraordinary Assessments.....	14
5.5	Replacement Reserves.....	14
5.6	Default in Payment of Assessments.....	15
5.7	Foreclosure of Liens for Unpaid Assessments.....	16
5.8	Statement of Assessments.....	16
5.9	Priority of Lien; First Mortgages.....	16
5.10	Voluntary Conveyance.....	16
ARTICLE 6 RECORDS AND AUDITS.....		16

6-26-03

6.1	General Records.....	16
6.2	Financial Records and Accounts.....	17
6.3	Assessment Roll.....	17
6.4	Payment of Vouchers.....	17
6.5	Reports and Audits.....	17
6.6	Notice of Sale, Mortgage, Rental or Lease.....	17
6.7	Availability of Records.....	17
6.8	Statement of Assessments Due.....	18
ARTICLE 7 MAINTENANCE AND USE OF CONDOMINIUM PROPERTY.....		18
7.1	Maintenance and Repair.....	18
7.2	Additions, Alterations or Improvements.....	18
7.3	Damage or Destruction by Casualty of Condominium Property.....	19
7.4	Condemnation.....	20
7.5	Restrictions and Requirements Respecting Use of Condominium Property.....	21
7.6	Abatement and Enjoining of Violations.....	23
ARTICLE 8 INSURANCE.....		24
8.1	Types of Insurance.....	24
8.2	Other Insurance Requirements.....	26
8.3	Optional Provisions.....	27
8.4	Fannie Mae and GNMA Requirements.....	27
ARTICLE 9 AMENDMENTS TO BYLAWS.....		28
9.1	How Proposed.....	28
9.2	Adoption.....	28
9.3	Execution and Recording.....	28
ARTICLE 10 DISPUTE RESOLUTION.....		28
10.1	Mediation.....	28
10.2	Arbitration.....	29
10.3	Selection of Arbitrator.....	29
10.4	Consolidated Arbitration.....	30
10.5	Discovery.....	30
10.6	Evidence.....	30
10.7	Excluded Matters.....	30
10.8	Costs and Attorneys' Fees.....	30

6-26-03

10.9 Survival 31
ARTICLE 11 MISCELLANEOUS 31
11.1 Notices 31
11.2 Waiver 31
11.3 Action Without a Meeting 31
11.4 Invalidity; Number; Captions 31
11.5 Conflicts 31

6-26-03

BYLAWS OF
MOSAIC CONDOMINIUM ASSOCIATION

Article 1

Plan of Condominium Ownership

1.1 **Name and Location.** These are the bylaws of the **MOSAIC CONDOMINIUM ASSOCIATION** (the "**Association**"). Mosaic Condominium (the "**Condominium**") is located in the City of Portland, Multnomah County, Oregon, and has been submitted to the Oregon Condominium Act by a declaration recorded simultaneously with these Bylaws (the "**Declaration**"). The location of the Condominium is more specifically described in the Declaration.

1.2 **Principal Office.** The principal office of the Association shall be located at 4 Monroe Parkway, Suite G, Lake Oswego, OR 97035, or such other address as may be designated by the board of directors from time to time.

1.3 **Purposes.** This Association is formed under the provisions of the Oregon Condominium Act to serve as the means through which the unit owners may take action with regard to the administration, management and operation of the Condominium.

1.4 **Applicability of Bylaws.** The Association, all unit owners, and all persons using the Condominium property shall be subject to these Bylaws and to all rules and regulations which may be adopted pursuant to these Bylaws.

1.5 **Composition of Association.** The Association shall be composed of all the unit owners of the Condominium, including Mosaic Portland Condominium, LLC, an Oregon limited liability company, and its successors and assigns (the "**Declarant**"), and the Association, itself, to the extent any of these own any unit or units of the Condominium.

1.6 **Incorporation.** The Association shall be incorporated under the Oregon Non-Profit Corporation Law. The Articles of Incorporation of the Association shall be consistent with the Declaration and these Bylaws, and these Bylaws shall constitute the bylaws of the incorporated association.

1.7 **Definitions.** The definitions contained in or adopted by the Declaration shall be applicable to these Bylaws.

6-26-03

Article 2

Meetings of Association

2.1 **Place of Meetings.** The Association shall hold meetings at such suitable place convenient to the unit owners as may be designated by the board of directors from time to time.

2.2 **Organizational and Turnover Meeting.** Within three years after the date of conveyance of the first unit to a person other than the Declarant, or within ninety (90) days after Declarant has sold and conveyed seventy-five percent (75%) or more of the units in the Condominium, whichever is earlier, the Declarant shall call the first meeting of the unit owners to organize the Association and to elect directors. Notice of such meeting shall be given to all owners as provided in Section 2.5. If Declarant fails to call the meeting, the meeting may be called and notice given by any unit owner or mortgagee of a unit. The expense of giving notice shall be paid or reimbursed by the Association. At the meeting, Declarant shall deliver to the Association such information and documents as may be required by the Oregon Condominium Act. Nothing in this Section shall be construed as preventing the Declarant from calling the organizational and turnover meeting prior to such date, or from calling informal, informational meetings of the unit owners.

2.3 **Annual Meetings.** The annual meetings of the Association shall be held on such date each year as may be established by the board of directors from time to time, or if the board does not establish such a date, then in the month of February at such hour and on such date as the chairperson may designate, or if the chairperson should fail to designate such date by the first day of February then on the last Tuesday in February. The annual meetings shall be for the purpose of electing directors and for the transaction of such other business as may properly come before the meeting.

2.4 **Special Meetings.** Special meetings of the Association may be called by the chairperson or by a majority of the board of directors, and must be called by such officers upon receipt of a written request from at least thirty percent (30%) of the unit owners stating the purpose of the meeting. Business transacted at a special meeting shall be confined to the purposes stated in the notice of meeting.

2.5 **Notice of Meetings.** Notice of the annual meeting and all other meetings of the Association stating the time and place and the purpose or purposes for which the meeting is being called shall be given by the chairperson or secretary. Such notice shall be in writing and mailed not less than ten (10) days nor more than fifty (50) days prior to the date of the meeting to each unit owner at his address as it appears on the books of the Association and to any first mortgagee requesting such notice. Proof of such mailing shall be given by the affidavit of the person giving the notice. Notice of meeting may be waived by any unit owner before or after meetings. When a meeting is adjourned for less than 30 days, no notice of the adjourned meeting need be given other than by announcement at the meeting at which such adjournment takes place.

2.6 **Voting.** Each unit owner shall have one vote for each unit of the Condominium owned by such unit owner. The Declarant shall be entitled to vote as the unit owner of any then existing units retained by the Declarant, and the board of directors shall be entitled to vote on

behalf of any unit which has been acquired by or on behalf of the Association; provided, however, that the board of directors shall not be entitled to vote such units in any election of directors.

2.7 **Absentee Ballots and Proxies.** A vote may be cast in person, by absentee ballot or by proxy. A proxy given by a unit owner to any person who represents such owner at meetings of the Association shall be in writing and signed by such owner, and shall be filed with the secretary, at any time prior to or at the start of the meeting. An owner may not revoke a proxy given pursuant to this Section except by actual notice of revocation to the person presiding over a meeting. A proxy shall not be valid if it is undated or purports to be revocable without notice. A proxy shall terminate one year after its date unless the proxy specifies a shorter term. Every proxy shall automatically cease upon sale of the unit by its owner. A unit owner may pledge or assign such owner's voting rights to a mortgagee. In such a case, the mortgagee or its designated representative shall be entitled to receive all notices to which the unit owner is entitled under these Bylaws and to exercise the unit owner's voting rights from and after the time that the mortgagee shall give written notice of such pledge or assignment to the board of directors. Any first mortgagee may designate a representative to attend all or any meetings of the Association.

2.8 **Fiduciaries and Joint Owners.** An executor, administrator, guardian or trustee may vote, in person or by proxy, at any meeting of the Association with respect to any unit owned or held in such capacity, whether or not the same shall have been transferred to his or her name; provided, that such person shall satisfy the secretary that he or she is the executor, administrator, guardian or trustee, holding such unit in such capacity. Whenever any unit is owned by two or more persons jointly, according to the records of the Association, the vote or proxy of such unit may be exercised by any one of the owners then present, in the absence of protest by a co-owner. In the event of disagreement among the co-owners, the vote of such unit shall be disregarded completely in determining the proportion of votes given with respect to such matter unless a valid court order establishes the authority of a co-owner to vote.

2.9 **Tenants and Contract Vendors.** Unless otherwise expressly stated in the rental agreement or lease, all voting rights allocated to a unit shall be exercised by the owner/landlord. Unless otherwise stated in the contract, all voting rights allocated to a unit shall be exercised by the vendee of any recorded land sale contract on the unit.

2.10 **Quorum of Unit Owners.** At any meeting of the Association, members holding twenty percent (20%) of the voting rights, present in person or by proxy, shall constitute a quorum. The subsequent joinder of a unit owner in the action taken at a meeting by signing and concurring in the minutes of the meeting shall constitute the presence of such person for the purpose of determining a quorum. When a quorum is once present to organize a meeting, it cannot be broken by the subsequent withdrawal of a unit owner or owners. If any meeting of members cannot be organized because of a lack of quorum, the members who are present, either in person or by proxy, may adjourn the meeting from time to time until a quorum is present. The quorum for the adjourned meeting shall be reduced to ten percent (10%) of the voting rights, present in person or by proxy.

2.11 **Majority Vote.** The vote of the holders of more than fifty percent (50%) of the voting rights, present in person or by proxy at a meeting at which a quorum is constituted, shall

be binding upon all unit owners for all purposes except where a higher percentage vote is required by law, by the Declaration or by these Bylaws.

2.12 **Order of Business.** The order of business at annual meetings of the Association shall be:

- (a) Calling of the roll and certifying of proxies;
- (b) Proof of notice of meeting or waiver of notice;
- (c) Reading of minutes of preceding meeting;
- (d) Reports of officers;
- (e) Reports of committees, if any;
- (f) Election of directors;
- (g) Unfinished business;
- (h) New business; and
- (i) Adjournment.

2.13 **Rules of Order.** Unless other rules of order are adopted by resolution of the Association or the board of directors, all meetings of the Association shall be conducted according to the latest edition of Robert's Rules of Order published by Robert's Rules Association.

2.14 **Ballot Meetings.**

(a) At the discretion of the board of directors, any action that may be taken at any annual, regular or special meeting of the Association may be taken without a meeting if the Association delivers a written ballot to every member that is entitled to vote on the matter. The written ballot shall set forth each proposed action and provide an opportunity to vote for or against each proposed action.

(b) The board of directors shall provide owners with at least ten (10) days' notice before written ballots are mailed or otherwise delivered. If, at least three (3) days before written ballots are scheduled to be mailed or otherwise distributed, at least ten percent (10%) of the owners petition the board of directors requesting secrecy procedures, a written ballot must be accompanied by a secrecy envelope, a return identification envelope to be signed by the owner and instructions for marking and returning the ballot. Notwithstanding the applicable provisions of paragraph (c) of this Section, written ballots that are returned in secrecy envelopes may not be examined or counted before the deadline for returning ballots has passed.

(c) If approval of a proposed action would otherwise require a meeting at which a certain quorum must be present and at which a certain percentage of total votes cast is required to authorize the action, the proposal will be deemed to be approved when the date for

6-26-03

return of ballots has passed, a quorum of unit owners has voted and the required percentage of approving votes has been received. Otherwise, the proposal shall be deemed to be rejected. If approval of a proposed action otherwise would require a meeting at which a specified percentage of unit owners must authorize the action, the proposal shall be deemed to be approved when the percentage of total votes cast in favor of the proposal equals or exceeds such required percentage. The proposal shall be deemed to be rejected when the number of votes cast in opposition renders approval impossible or when both the date for return of ballots has passed and such required percentage has not been met. Except as otherwise provided in paragraph (b) of this Section, votes may be counted from time to time before the final return date to determine whether the proposal has passed or failed by the votes already cast on the date they are entered.

(d) All solicitations for votes by written ballot shall state the number of responses needed to meet any applicable quorum requirement and the total percentage of votes needed for approval. All such solicitations for votes shall specify the period during which the Association will accept written ballots for counting, which period shall end on the earliest of (i) the date on which the Association has received a sufficient number of approving ballots to pass the proposal, or (ii) the date on which the Association has received a sufficient number of disapproving ballots to render the proposal impossible of passage, or (iii) a date certain on which all ballots must be returned to be counted. A written ballot may not be revoked.

Article 3

Board of Directors

3.1 Number and Qualification. The affairs of the Association shall be governed by a board of directors composed of two (2) interim directors or three (3) to five (5) regular directors, as provided in Sections 3.2 and 3.4 of this Article. All directors, other than interim directors appointed by Declarant, shall be owners or co-owners of units of the Condominium. For purposes of this Section, the officers and any duly appointed employees of any corporate owner, the members of any limited liability company and the partners of any partnership shall be considered co-owners of any units owned by such corporation, limited liability company or partnership.

3.2 Interim Directors. Upon the recording of the Declaration submitting the Condominium to the Oregon Condominium Act the Declarant shall appoint an interim board of two (2) directors, who shall serve until replaced by Declarant or their successors have been elected by the unit owners as provided below.

3.3 Transitional Committee. Unless the organizational and turnover meeting described in Section 2.2 above has already been held, Declarant shall call a meeting of the unit owners for the purpose of forming a transitional committee. The meeting shall be called within sixty (60) days of conveyance to persons other than Declarant of fifty percent (50%) of the units. Declarant shall give notice of the meeting as provided in Section 2.5 above. The committee shall consist of two or more members elected by the unit owners other than Declarant and not more than one representative of Declarant. The members shall serve until the organizational and turnover meeting. The transitional committee shall be advisory only and its purpose shall be to enable ease of transition from control of the administration of the Association by the Declarant to control by the unit owners. The committee shall have access to the information, documents and

records which Declarant must turn over to the unit owners at the time of the organizational and turnover meeting. If Declarant fails to call the meeting to elect a transitional committee within the time specified, the meeting may be called and notice given by any unit owner.

3.4 **Election and Term of Office.** At the first organizational and turnover meeting called by Declarant pursuant to Section 2.2 of these Bylaws, the interim directors shall resign and three (3) successors shall be elected, one to serve until the next annual meeting and two to serve until the second annual meeting after their election. The candidates receiving the greatest number of votes shall be elected to the two-year terms. Thereafter, at the expiration of the initial term of office of each respective director, his or her successor shall be elected to serve for a term of two years, so that the term of not less than one-third of the directors shall expire annually. Directors shall hold office until their respective successors have been elected by the unit owners. Election shall be by plurality. Upon a majority vote of the membership present in person or by proxy at a meeting called for such purpose, the number of directors may be increased to five (5) directors. Upon such increase, two additional directors shall be elected, one to serve until the next annual meeting and the other to serve until the second annual meeting after their election. Thereafter, each successor shall be elected to serve for a two-year term. Voting shall be by secret ballot.

3.5 **Vacancies.** Vacancies in the board of directors caused by any reason other than the removal of a director by a vote of the Association shall be filled by vote of the majority of the remaining directors, even though they may constitute less than a quorum, or by a sole remaining director. Each person so elected shall be a director until a successor is elected to fill the unexpired term at the next annual meeting of the Association or the next special meeting of the Association called for that purpose. Vacancies in interim directors shall be filled by Declarant.

3.6 **Removal of Directors.** At any regular or special meeting of the Association duly called, any one or more of the directors, other than interim directors, may be removed with or without cause by a majority vote of the unit owners present in person or by proxy, and a successor shall be elected at that meeting to fill the vacancy thus created. The notice of any such meeting shall state that such removal is to be considered, and any director whose removal has been proposed shall be given an opportunity to be heard at that meeting.

3.7 **Powers and Duties.** The board of directors shall have all of the powers and duties necessary for the administration of the affairs of the Association, except such powers and duties as by law or by the Declaration or by these Bylaws may not be delegated to the board of directors by the unit owners. The powers and duties to be exercised by the board of directors shall include, but shall not be limited to the following:

(a) Operation, care, upkeep, maintenance, repair and replacement of the general and limited common elements and Association property, including, without limitation, maintenance of the "Eco-Roof" systems on the upper and lower roofs as required by the Operation & Maintenance Agreement with the City of Portland recorded August 9, 2001 as Document No. 2001-124809.

(b) Determination of the amounts required for operation, maintenance and other affairs of the Association, and the making of such expenditures.

6-26-03

(c) Preparation and adoption of budgets, preparation, review and update of reserve studies and assessment and collection of the common expenses, all in accordance with the provisions of these Bylaws.

(d) Employment and dismissal of such personnel as necessary for the efficient maintenance, upkeep and repair of the common elements.

(e) Employment of legal, accounting or other personnel for reasonable compensation to perform such services as may be required for the proper administration of the Association; provided, however, the board may not incur or commit the Association to incur legal fees in excess of \$5,000 for any specific matter unless the unit owners have enacted a resolution authorizing the incurring of such fees by a vote of seventy-five percent (75%) of the voting rights of the Association. This limitation shall not be applicable to legal fees incurred in defending the Association and the board of directors from claims or litigation brought against them. The limitation set forth in this paragraph shall increase by \$500 on each fifth anniversary of the recording of the Declaration. To the extent required by ORS 100.490, the board shall notify the owners prior to instituting litigation or administrative proceedings. With regard to any pending litigation involving the Association, the board shall periodically report to the unit owners as to the status (including settlement offers), progress, and method of funding such litigation. Nothing in this paragraph shall be construed as requiring the board to disclose any privileged communication between the Association and its counsel.

(f) Opening of bank accounts on behalf of the Association and designating the signatories required therefor.

(g) Preparation and distribution of annual financial statements in accordance with these Bylaws and annual preparation and filing of all required income tax returns or forms for the Association.

(h) Purchasing units of the Condominium at foreclosure or other judicial sales in the name of the Association, or its designee, on behalf of all the unit owners as provided in these Bylaws.

(i) Selling, leasing, mortgaging, voting the votes appurtenant to (other than for the election of directors), or otherwise dealing with units of the Condominium acquired by the Association or its designee on behalf of all the unit owners.

(j) Obtaining insurance or bonds pursuant to the provisions of these Bylaws and at least annually review the insurance coverage of the Association.

(k) Making additions and improvements to, or alterations of, the common elements; provided, however, that no such project may be undertaken by the board if the total cost will exceed the amount of \$20,000 unless the unit owners have enacted a resolution authorizing the project by a majority vote of the members. This limitation shall not be applicable to maintenance, repairs or replacement undertaken pursuant to paragraph (a) above. The limitation set forth in this paragraph shall increase by \$1,000 on each anniversary of the recording of the Declaration.

(l) Modify, close, remove, eliminate or discontinue the use of a general common element facility or improvement or portion of the common element landscaping.

(m) Designating one or more committees which, to the extent provided in the resolution designating the committee, shall have the powers of the board of directors in the management of the affairs of the Association. At least one member of each committee shall be a member of the board of directors.

(n) Enforcement by legal means of the provisions of the Oregon Condominium Act, the Declaration, these Bylaws and any rules and regulations adopted hereunder. Nothing in these Bylaws shall be construed as requiring the Association to take any specific action to enforce violations.

(o) The filing of an Annual Report and any amendment in accordance with ORS 100.250.

(p) Establish, periodically update, and implement a Maintenance Plan which identifies those components of the common elements requiring periodic maintenance, including a maintenance manual defining how and when such maintenance should be performed and setting forth the estimated cost of such maintenance. The operating and reserve budgets of the Association shall take into account such costs. Changes or updates to the Maintenance Plan should be based upon the advice of competent experts or consultants.

(q) Initiate or intervene in litigation or administrative proceedings (including mediation under Article 10 of these Bylaws) in the name of the Association, and without joining the individual unit owners, as permitted under ORS 100.405(4)(e) and (11); provided that no litigation or administrative proceeding may be initiated on a matter relating to or affecting the unit or interest of a unit owner unless the unit owner has consented in writing to such action after full disclosure of the potential cost, duration and outcomes of the proposed litigation or administrative proceeding.

3.8 **Managing Agent or Manager.** On behalf of the Association, the board of directors may employ or contract for a managing agent or a manager at a compensation to be established by the board of directors. Any such management agreement shall be terminable by the Association upon not more than 90 days' written notice thereof. The board of directors may delegate to the managing agent or manager such duties and powers as the board of directors may authorize. In the absence of such appointment, the board of directors shall act as manager; provided, however, that, the board of directors may not terminate professional management and assume self-management unless the decision to do so is approved by at least seventy-five percent (75%) of the total voting power of the Association.

3.9 **Contracts Entered into by Declarant or Interim Board.** Notwithstanding any other provision of these Bylaws, any leases or contracts (including management contracts, service contracts and employment contracts) entered into by the Declarant or the interim board on behalf of the Association shall have a term not in excess of three years. In addition, any such lease or contract shall provide that it may be terminated without cause or penalty by the Association or board of directors upon not less than 30 days' notice to the other party given at

any time after election of the permanent board at the organizational and turnover meeting described in Section 2.2 of these Bylaws.

3.10 **Organizational Meeting.** Unless otherwise agreed by the board, within fourteen (14) days following the annual meeting of the Association or following any meeting at which an election of directors has been held, the board of directors shall hold an organization meeting at such place and time as shall have been fixed by the directors at the meeting at which the election was held.

3.11 **Regular and Special Meetings.** Regular meetings of the board of directors may be held at such time and place as shall be determined, from time to time, by a majority of the directors. Special meetings of the board of directors may be called by the chairperson and must be called by the secretary at the written request of at least two directors. Notice of any special meeting shall be given to each director, personally or by mail, telephone or telegraph at least seven (7) days prior to the day named for such meeting, and shall state the time, place and purpose of such meeting. Unless other rules of order are adopted by resolution of the Association or the board of directors, all meetings of the board of directors shall be conducted according to the latest edition of Robert's Rules of Order published by Robert's Rules Association.

3.12 **Open Meetings.** All meetings of the board of directors shall be open to unit owners except that, in the discretion of the board, the following matters may be considered in executive session: (a) consultation with legal counsel concerning the rights and duties of the Association regarding existing or potential litigation, or criminal matters; (b) personnel matters, including salary negotiations and employee discipline; and (c) the negotiation of contracts with third parties. Except in the case of an emergency, the board of directors shall vote in an open meeting whether to meet in executive session. If the board of directors votes to meet in executive session, the presiding officer shall state the general nature of the action to be considered and, as precisely as possible, when and under what circumstances the deliberations can be disclosed to owners. Meetings of the board of directors may be conducted by telephonic communication, except that if a majority of the units are principal residences of the occupants, then: (a) for other than emergency meetings, notice of each board of directors' meeting shall be posted at a place or places on the property at least three (3) days prior to the meeting, or notice shall be provided by a method otherwise reasonably calculated to inform the unit owners of such meeting; and (b) only emergency meetings of the board of directors may be conducted by telephonic communication. The meeting and notice requirements of this Section may not be circumvented by chance or social meetings or by any other means.

3.13 **Waiver of Notice.** Any director may, at any time, waive notice of any meeting of the board of directors in writing, and such waiver shall be deemed equivalent to the giving of such notice. Attendance by a director at any meeting of the board shall constitute a waiver of notice by such director, except where the director attends the meeting for the express purpose of objecting to the transaction of any business because the meeting is not lawfully called or convened. If all of the directors are present at any meeting of the board, no notice to directors shall be required and any business may be transacted at such meeting.

3.14 **Quorum of Board of Directors.** At all meetings of the board of directors, a majority of the directors shall constitute a quorum for the transaction of business, and the votes

PortInd1-2116690.3 0040198-00002

6-26-03

of a majority of the directors present at a meeting at which a quorum is present shall constitute the decision of the board of directors. If at any meeting of the board of directors less than a quorum should be present, a majority of those present may adjourn the meeting from time to time. At any such adjourned meeting at which a quorum is present, any business which might have been transacted at the meeting originally called may be transacted without further notice to directors.

3.15 **Compensation.** No director shall receive any compensation from the Association for acting as such.

3.16 **Liability and Indemnification of Directors, Officers and Managing Agent.** A member of the board of directors or an officer of the Association shall not be liable to the Association, any unit owner or any third party for any damage, loss or prejudice suffered or claimed on account of any action or failure to act in the performance of his or her duties, except for acts of gross negligence or intentional acts. A director appointed under Section 3.2 of these Bylaws and Section 14.4 of the Declaration, or acting under ORS 100.200, shall not be liable to the Association, any unit owner or any third party under ORS 65.357-65.361, ORS 100.417 or associated rules of common law for any damage, loss or prejudice suffered or claimed on account of any action or failure to act that represents the exercise of authority established in Section 14.4 of the Declaration and ORS 100.200, including any action or failure to act requested by the Declarant or resulting from any prior or concurrent duty or loyalty owed by such director to the Declarant; provided that nothing in this section limits the liability of the Declarant for such actions or failure to act by a director. In the event any member of the board of directors or any officer of the Association is threatened with or made a party to any proceeding because the individual was or is a director or officer of the Association, the Association shall defend such individual against such claims and indemnify such individual against liability and expenses incurred to the maximum extent permitted by law. The managing agent of the Association, and its officers and employees, shall not be liable to the Association, the unit owners or any third party on account of any action or failure to act in the performance of its duties as managing agent, except for acts of gross negligence or intentional acts. Prior to the Organizational and Turnover Meeting described in Section 2.2, the managing agent shall not be liable to the Association, any unit owner or any third party for any damage, loss or prejudice suffered or claimed on account of any action or failure to act that represents the exercise of authority established in Section 14.4 of the Declaration and ORS 100.200, including any action or failure to act requested by the Declarant or resulting from any prior or concurrent duty or loyalty owed by such director to the Declarant; provided that nothing in this section limits the liability of the Declarant for such actions or failure to act by the managing agent. In the event the managing agent is threatened with or made a party to any proceeding, the Association shall defend the managing agent against such claims and indemnify the managing agent and its officers and employees from any such claims to the maximum extent permitted by law.

3.17 **Insurance.** The board of directors shall obtain the insurance and fidelity bonds required in Article 8 of these Bylaws. In addition, the board of directors, in its discretion, may obtain such other insurance as it deems necessary to protect the interests of the Association or unit owners. The board of directors shall conduct an annual insurance review which, if appropriate, shall include an appraisal of all improvements contained in the Condominium.

Article 4

Officers

4.1 **Designation.** The principal officers of the Association shall be the chairperson, the secretary and the treasurer, all of whom shall be elected by the board of directors. The directors may appoint a vice chairperson, an assistant treasurer, an assistant secretary, and such other officers as in their judgment may be necessary. The chairperson shall be a member of the board of directors, but the other officers need not be directors or unit owners.

4.2 **Election of Officers.** The officers of the Association shall be elected annually, by the board of directors at the organization meeting of each new board and shall hold office at the pleasure of the board. If any office shall become vacant, the board of directors shall elect a successor to fill the unexpired term at any regular meeting of the board of directors, or at any special meeting of the board of directors called for such purpose.

4.3 **Removal of Officers.** Upon the affirmative vote of a majority of the directors, any officer may be removed either with or without cause, and a successor may be elected at any regular meeting of the board of directors, or at any special meeting of the board of directors called for such purpose.

4.4 **Chairperson.** The chairperson shall be the chief executive officer of the Association. He or she shall preside at all meetings of the Association and of the board of directors. The chairperson shall have all of the general powers and duties which are usually vested in the chief executive officer of an association, including but not limited to the power to appoint committees from among the unit owners from time to time as the chairperson may in his or her discretion decide is appropriate to assist in the conduct of the affairs of the Association.

4.5 **Secretary.** The secretary shall keep the minutes of all proceedings of the board of directors and the minutes of all meetings of the Association. He or she shall attend to the giving and serving of all notices to the unit owners and directors and other notices required by law. The secretary shall keep the records of the Association, except for those of the treasurer, and shall perform all other duties incident to the office of secretary of an association and as may be required by the directors or the chairperson. In addition, the secretary shall act as vice chairperson, taking the place of the chairperson and performing the chairperson's duties whenever the chairperson is absent or unable to act, unless the directors have appointed another vice chairperson.

4.6 **Treasurer.** The treasurer shall have the responsibility for Association funds and securities and shall be responsible for keeping full and accurate financial records and books of account showing all receipts and disbursements, and for the preparation of required financial statements. He or she shall be responsible for overseeing the deposit of all moneys and other valuable effects in such depositories as may from time to time be designated by the board of directors, and shall disburse or cause to be disbursed funds of the Association upon properly authorized vouchers. The treasurer shall perform all other duties incident to the office of treasurer of an association and such other duties as may be assigned to him or her by the board of directors.

4.7 **Execution of Instruments.** All agreements, contracts, deeds, leases and other instruments of the Association, except checks, shall be executed by such person or persons as may be designated by general or special resolution of the board of directors and, in the absence of any general or special resolution applicable to any such instrument, then such instrument shall be signed by the chairperson. All checks shall be signed by the treasurer, or in the absence or disability of the treasurer, by the chairperson or any duly elected assistant treasurer, or by the managing agent.

4.8 **Compensation of Officers.** No officer who is a member of the board of directors shall receive any compensation from the Association for acting as an officer, unless such compensation is authorized by a resolution duly adopted by the unit owners. The board of directors may fix any compensation to be paid to any officers who are not also directors.

Article 5

Budget, Expenses and Assessments

5.1 **Budget.** The board of directors shall from time to time, and at least annually, prepare a budget for the Association, estimate the common expenses expected to be incurred, less any previous overassessment and plus any underassessment, and assess the common expenses to each unit owner in the proportion set forth in the Declaration. The budget shall provide for a reserve fund in accordance with Section 5.5 below and shall take into account the Maintenance Plan adopted pursuant to Section 3.7(p) above. Within thirty (30) days after adopting the annual budget, the board of directors shall provide a summary of the budget to all owners. If the board of directors fails to adopt an annual budget, the last adopted budget shall continue in effect.

5.2 **Determination of Common Expenses.**

- (a) Common expenses shall include:
- (b) Expenses of administration, including management fees.
- (c) Expenses of maintenance, repair or replacement of common elements, any other portions of the Condominium required to be maintained by the Association pursuant to the Declaration or these Bylaws, and any Association property.
- (d) Cost of insurance or bonds obtained in accordance with these Bylaws.
- (e) A general operating reserve, including an amount sufficient to cover the deductible under the property damage insurance policy.
- (f) Reserve for replacements, repairs and maintenance.
- (g) Any deficit in common expenses for any prior period.
- (h) Utilities and services for the common elements and other utilities and services with a common meter or commonly billed, such as trash collection, hot water, water and sewer.

6-26-03

- (i) Any other items properly chargeable as an expense of the Association.

5.3 **Assessment of Common Expenses.**

(a) **Obligation to pay.** All unit owners shall be obligated to pay common expenses assessed to them by the board of directors on behalf of the Association pursuant to these Bylaws and the Declaration. No unit owner by the owner's own action may claim exemption from liability for contribution towards common expenses by waiver by the owner of use or enjoyment of any of the common elements or by abandonment by the owner of the owner's unit. A unit owner may not claim an offset against an assessment for failure of the Association to perform its obligations and no unit owner may offset amounts owing or claimed to be owing by the Association or Declarant to the unit owner. Declarant shall be assessed as the unit owner of any unsold unit, but such assessments shall be prorated to the date of sale of the unit. The board of directors, on behalf of the Association shall assess the common expenses against the unit owners from time to time, and at least annually, and shall take prompt action to collect from a unit owner any common expense due which remains unpaid for more than thirty (30) days from the due date for its payment. The board may elect to round assessments to the nearest dollar.

(b) **Working capital fund.** Declarant shall establish an initial working capital fund in an amount at least equal to two (2) months of estimated regular association assessments for each unit. At the time of closing of the initial sale of each unit and thereafter on any subsequent sale of a unit, the purchaser shall make a contribution to the working capital of the Association equal to two months' regular association assessments for the unit. At the time of the organizational and turnover meeting, the Declarant shall pay such contribution for all unsold units, but may obtain reimbursement for such sums from the purchaser upon the sale of each such unit. Such contribution shall be in addition to the regular monthly common expense assessment and shall not be considered as an advance payment of regular assessments. The working capital fund shall be transferred to the Association for deposit to a segregated fund at the time of the organizational and turnover meeting. Declarant may not use the working capital fund to defray any of Declarant's expenses, reserve contributions, or construction costs or to make up any budget deficits while Declarant is in control of the Association. After the organizational and turnover meeting, the board of directors, at its discretion, may use working capital funds for regular operating expenses, extraordinary items of maintenance, repair or replacement or capital additions, or may deposit all or a portion of such funds into the reserve account.

(c) **Commencement of regular operating expense assessments.** Regular monthly assessments for common operating expenses shall commence upon closing of the first sale of a unit in the Condominium.

(d) **Commencement of assessment for replacement reserves.** Regular monthly assessments for replacement reserves as described in Section 5.5 for all units in the Condominium shall commence upon the closing of the sale of the first unit in the Condominium. Declarant may elect to defer payment of such reserve assessments to the Association for each unit owned by Declarant until the closing of the sale of such unit, but not beyond the date of the turnover meeting referred to in Section 2.2 above, or if no turnover meeting is held, the date the

owners assume administrative control of the Association. The books and records of the Association shall reflect the amount owing from Declarant for all reserve assessments.

5.4 **Special or Extraordinary Assessments.**

(a) **Special Assessments for Capital Improvements.** In the case of any duly authorized capital improvement to the common elements, the board of directors may by resolution establish separate assessments for the same, which may be treated as capital contributions by the unit owners, and the proceeds of which shall be used only for the specific capital improvements described in the resolution. The Association shall not assess units owned by the Declarant for additional capital improvements to the Condominium without the written consent of Declarant as long as Declarant owns more than two units.

(b) **Other Special or Extraordinary Assessments.** In the event the board of directors determines that the assessments established upon adoption of the budget as provided in Section 5.1 above will be insufficient to pay the common expenses, or the board of directors determines that additional funds will be needed to meet unexpected or unbudgeted common expenses, the board may levy an additional special or extraordinary assessment. Such assessment shall be allocated to each unit in the same proportion set forth in the Declaration, and may be payable in installments over a specified period, in a lump sum, or in a lump sum with option to pay in installments with interest, as determined by the board of directors.

5.5 **Replacement Reserves.**

(a) **Establishment of Account.** The Declarant shall conduct a reserve study as described in paragraph (c) of this Section and establish a reserve account for replacement of those common elements all or a part of which will normally require replacement in more than three (3) and less than thirty (30) years, for significant future maintenance items as required by the Maintenance Plan established pursuant to Section 3.7(p) and for exterior painting if the common elements include exterior painted surfaces. The reserve account need not include those items that could reasonably be funded from operating assessments.

(b) **Funding of Account.** The reserve account shall be funded by assessments against the individual units for the purposes for which the reserve account is being established, which sums shall be included in the regular monthly assessment for the unit, except as otherwise provided in Section 5.3(b). The reserve account shall be established in the name of the Association.

(c) **Reserve Studies.** The board of directors annually shall conduct a reserve study or review and update an existing study to determine the reserve account requirements for the items described in paragraph (a) of this Section and may adjust the amount of payments in accordance with the study or review and may provide for other reserve items that the board of directors, in its discretion, may deem appropriate. The reserve account need not include items that could reasonably be funded from operating assessments. The reserve study shall include:

- (i) Identification of all items for which reserves are to be established;
- (ii) The estimated remaining useful life of each item as of the date of

the reserve study;

PortIn41-2116690.3 0040198-00002

6-26-03

(iii) An estimated cost of maintenance, repair or replacement of each item at the end of its useful life;

(iv) An update of the Maintenance Plan based upon the advice of competent experts or consultants; and

(v) A thirty (30) year plan with regular and adequate contributions, adjusted by estimated inflation and interest earned on reserves, to meet the maintenance, repair and replacement schedule.

(d) **Use of Reserve Funds.** The reserve account shall be used only for the purposes for which the reserves have been established and shall be kept separate from other funds. After the organizational and turnover meeting described in Section 2.2, however, the board of directors may borrow funds from the reserve account to meet high seasonal demands on the regular operating funds or to meet unexpected increases in expenses which will later be paid from assessments, if the board of directors has adopted a resolution, which may be an annual continuing resolution, authorizing the borrowing of funds. Not later than the adoption of the budget for the following year, the board of directors shall adopt by resolution a written payment plan providing for repayment of the borrowed funds within a reasonable period. In addition to the authority of the board of directors under paragraph (c) of this Section, after the organizational and turnover meeting, the Association may, on an annual basis, elect not to fund the reserve account described in paragraph (a) of this Section by unanimous vote of the owners or elect to reduce or increase future assessments for the reserve account by an affirmative vote of at least seventy-five percent (75%) of the voting power.

(e) **Sale of Units.** Nothing in this Section shall prohibit prudent investment of the reserve account. Assessments paid into the reserve account are the property of the Association and are not refundable to sellers of units. Sellers of the units, however, may treat their outstanding share of the reserve account as a separate item in any sales agreement.

5.6 **Default in Payment of Assessments.** In the event of default by any unit owner in paying any assessments to the Association, including assessed common expenses and any other charge imposed or levied by the Association pursuant to the provisions of the Declaration, these Bylaws or the Oregon Condominium Act, such unit owner shall be obligated to pay interest at the rate of twelve percent (12%) per annum on such assessment from the due date thereof, or at such greater rate as may be established by the board of directors from time to time, not to exceed the maximum lawful rate, if any. In addition, the defaulting unit owner shall pay a late charge for any assessment not paid within ten (10) days of its due date in the amount of five percent (5%) of the delinquent payment, or such other reasonable late charge or administrative fee, or both, as may be established by the board of directors from time to time by resolution that is delivered to each unit, mailed to the mailing address of each unit or mailed to the mailing address designated by the unit owner in writing, together with all expenses incurred by the Association in collecting such unpaid assessments, including attorneys' fees (whether or not suit is instituted, and at trial or any appeal or petition for review therefrom). If the assessment is not paid within thirty (30) days of its due date, the board of directors may declare any remaining installments of assessments for the balance of the fiscal year immediately due and payable. The board of directors shall have the right and duty to recover for the Association such assessments, together with such charges, interest and expense of the proceeding, including attorneys' fees, by an action

brought against such unit owner or by foreclosure of the lien upon the unit granted by the Oregon Condominium Act. The board of directors shall notify the holder of any first mortgage upon a unit and any eligible mortgage insurer or guarantor thereof of any default not cured within sixty (60) days of the date of default.

5.7 **Foreclosure of Liens for Unpaid Assessments.** In any suit brought by the Association to foreclose a lien on a unit because of unpaid assessments, the unit owner shall be required to pay a reasonable rental for the use of the unit during the pendency of the suit, and the plaintiff in such foreclosure suit shall be entitled to the appointment of a receiver to collect such rental. The board of directors, acting on behalf of the Association, shall have the power to purchase such unit at the foreclosure sale and to acquire, hold, lease, mortgage, vote the votes appurtenant to, convey, or otherwise deal with the unit. A suit or action to recover a money judgment for unpaid assessments shall be maintainable without foreclosing the liens securing the same.

5.8 **Statement of Assessments.** The board of directors shall advise each unit owner in writing of the amount of assessments payable by such owner, and furnish copies of each budget on which such assessments are based to all unit owners and, if requested, to their mortgagees. The board of directors shall promptly provide any unit owner who makes a request in writing with a written statement of the owner's unpaid assessments.

5.9 **Priority of Lien; First Mortgages.** Any lien of the Association against a unit for assessments shall be subordinate to tax and assessment liens and any prior mortgage of record. Where the purchaser or mortgagee of a unit obtains title to the unit as a result of foreclosure of a first mortgage, such purchaser or mortgagee, its successors and assigns, shall not be liable for any of the assessments chargeable to such unit which became due prior to the acquisition of title to such unit by such purchaser or mortgagee. Such unpaid share of assessments shall be a common expense and reallocated on a pro rata basis for all units, including the mortgaged unit. The purchaser or mortgagee shall not be relieved of the obligation to pay further assessments. A deed in lieu of foreclosure accepted by the holder of a first mortgage shall extinguish a lien filed by the Association to secure unpaid assessments under the circumstances described in ORS 100.465.

5.10 **Voluntary Conveyance.** In a voluntary conveyance of a unit, the grantee shall be jointly and severally liable with the grantor for all unpaid assessments against the grantor of the unit up to the time of the grant or conveyance, without prejudice to the grantee's right to recover from the grantor the amounts paid by the grantee therefor. However, upon request of a prospective purchaser the board of directors shall make and deliver a statement of the unpaid assessments against the prospective grantor or the unit, and the grantee in that case shall not be liable for, nor shall the unit when conveyed be subject to, a lien filed thereafter for any unpaid assessments against the grantor in excess of the amount set forth in the statement.

Article 6

Records and Audits

6.1 **General Records.** The board of directors and the managing agent or manager, if any, shall keep detailed records of the actions of the board of directors and the managing agent or

manager, minutes of the meetings of the board of directors and minutes of the meetings of the Association. The board of directors shall maintain a Book of Resolutions containing the rules, regulations and policies adopted by the Association, board of directors and the manager. The board of directors shall maintain a list of owners entitled to vote at meetings of the Association and a list of all mortgagees of units. All documents, information and records delivered to the Association by the Declarant pursuant to ORS 100.210 shall be kept within the State of Oregon.

6.2 **Financial Records and Accounts.** The board of directors or its designee shall keep within the State of Oregon financial records sufficient for proper accounting purposes. All assessments shall be deposited in a separate bank account, located in the State of Oregon, in the name of the Association. All expenses of the Association shall be paid from the Association's bank account.

6.3 **Assessment Roll.** The assessment roll shall be maintained in a set of accounting books in which there shall be an account for each unit. Such account shall designate the name and address of the owner or owners, the amount of each assessment against the owners, the dates and amounts in which the assessment comes due, the amounts paid upon the account and the balance due on the assessments.

6.4 **Payment of Vouchers.** The treasurer or managing agent shall pay all vouchers for all budgeted items and for any nonbudgeted items up to \$1,000 signed by the chairperson, managing agent, manager or other person authorized by the board of directors. Any voucher for nonbudgeted items in excess of \$1,000 shall require the authorization of the chairperson. Any checks written on reserve accounts must be signed by a member of the board of directors.

6.5 **Reports and Audits.** An annual financial statement consisting of a balance sheet and income and expense statement for the preceding fiscal year shall be rendered by the board of directors to all unit owners and to all mortgagees of units who have requested the same within ninety (90) days after the end of each fiscal year. From time to time the board of directors, at the expense of the Association, may obtain an audit or review of the books and records pertaining to the Association and furnish copies thereof to the owners and such mortgagees. Upon written request, any holder, insurer or guarantor of a first mortgage shall be entitled to an audited financial statement for the immediately preceding fiscal year at the expense of the requesting party, if one is not otherwise available.

6.6 **Notice of Sale, Mortgage, Rental or Lease.** Immediately upon the sale, mortgage, rental or lease of any unit, the unit owner shall promptly give written notice to the secretary or manager of the name and address of said vendee, mortgagee, lessee, or tenant.

6.7 **Availability of Records.** During normal business hours or under other reasonable circumstances, the Association shall make available to unit owners, prospective purchasers and lenders, and to holders, insurers, or guarantors of any first mortgage, current copies of the Declaration, bylaws, other rules concerning the Condominium, amendments or supplements to such documents, and the books, records, financial statements and current operating budget of the Association. Upon written request, the Association shall make such documents, information and records available to such persons for duplication during reasonable hours. The Association may charge a reasonable fee for furnishing copies of such documents,

information or records. The fee may include reasonable personnel costs incurred to furnish the information.

6.8 **Statement of Assessments Due.** The Association shall provide, within ten (10) business days of receipt of a written request from an owner, a written statement that provides: (a) the amount of assessments due from the owner and unpaid at the time the request was received, including regular and special assessments, fines and other charges, accrued interest, and late payment charges; (b) the percentage rate at which interest accrues on assessments that are not paid when due; and (c) the percentage rate used to calculate the charges for late payment or the amount of a fixed rate charge for late payment. The Association is not required to comply with this Section if the Association has commenced litigation by filing a complaint against the owner and the litigation is pending when the statement would otherwise be due.

Article 7

Maintenance and Use of Condominium Property

7.1 **Maintenance and Repair.** Except as otherwise provided in Section 7.3 for damage or destruction caused by casualty:

(a) **Units.** All maintenance of and repairs to any unit shall be made by the owner of such unit, who shall keep the same in good order, condition and repair and shall do all redecorating, painting and staining which at any time may be necessary to maintain the good appearance and condition of his unit. In addition, each unit owner shall be responsible for the maintenance, repair, or replacement of interior doors (except entry doors) and any plumbing, heating or air conditioning fixtures, telephones, water heaters, fans, vents, lighting fixtures and lamps, electrical outlets, blinds, garbage disposals, fireplaces, refrigerators, dishwashers, ranges, or other appliances and accessories that may be in or connected with such owner's unit. The Association, however, may repair or replace, at the Association's expense, windows, the glass curtain wall, entry and exterior doors to the units, and portions of units to the extent reasonably necessary for the preservation of the common elements in good condition and working order.

(b) **Common elements.** All maintenance, repairs and replacements to the general and limited common elements and to Association property shall be made by the Association and shall be charged to all the unit owners as a common expense. Each unit owner, however, shall keep the limited common elements which pertain to such owner's unit in a safe, neat, clean and sanitary condition.

7.2 Additions, Alterations or Improvements.

(a) A unit owner may not make any improvements or alterations to such owner's unit without first notifying the Association and obtaining approval by the board of directors of the proposed alteration. The owner shall have the burden of establishing, to the reasonable satisfaction of the board of directors, that the proposed improvements or alterations will not impair the structural integrity or mechanical systems of the Condominium, lessen the support of any portion of the Condominium, jeopardize the soundness or safety of the Condominium, reduce its value, impair any easement or hereditament, increase the common expenses or increase sound transmissions to other units. The board of directors may elect to

6-26-03

require contractors to coordinate their access and working hours so as to minimize disruption to the Condominium. A unit owner shall reimburse the Association for any actual costs incurred by the Association in reviewing and monitoring such alterations.

(b) After acquiring an adjoining unit or an adjoining part of an adjoining unit, a unit owner may submit a written request to the board of directors for permission to remove or alter any intervening partition or to create apertures therein, even if the partition in whole or in part is a common element. The board of directors shall approve the change unless it determines within forty-five (45) days that the proposed change will impair the structural integrity or mechanical systems of the Condominium or lessen the support of any portion of the Condominium. The board of directors may require the unit owner, at such owner's own expense, to submit an opinion of a registered architect or registered professional engineer that the proposed change will not impair the structural integrity or mechanical systems of the Condominium or lessen the support of any portion of the Condominium. Removal of partitions or creation of apertures under this paragraph is not an alteration of boundaries.

(c) A unit owner may not change the appearance of the common elements or the exterior appearance of a unit without the prior written permission of the board of directors.

7.3 Damage or Destruction by Casualty of Condominium Property. In the case of damage or destruction which affects a material portion of the project, timely written notice shall be given to the unit owners and their mortgagees and any eligible mortgage insurer or guarantor and the following provisions shall apply:

(a) In the event of damage or destruction by casualty of Condominium property, the damage or destruction shall be repaired, reconstructed or rebuilt unless, within fourteen (14) days of such damage or destruction, the board of directors or more than ten percent (10%) of the unit owners shall have requested a special meeting of the Association. Such special meeting must be held within sixty (60) days of the date of damage or destruction. At the time of such meeting, unless unit owners holding ninety percent (90%) of the voting power, whether in person, by writing or by proxy, with the approval of mortgagees as required by the Declaration, vote not to repair, reconstruct or rebuild the damaged property, the damage or destruction shall be repaired, reconstructed or rebuilt. If the damage or destruction is not repaired, reconstructed or rebuilt, then the property shall be removed from condominium ownership in the manner provided in the Oregon Condominium Act.

(b) The Association shall be responsible for repairing, reconstructing or rebuilding all such damage or destruction to the common elements and, to the extent of the Association's insurance coverage, all such damage or destruction to the units. Each unit owner shall be responsible for such repairing, reconstructing or rebuilding of his unit as is not so covered by the Association's insurance and to the extent of any deductible under the Association's insurance.

(c) If, due to the act or neglect of a unit owner, or of a member of such owner's family or household pet or of a guest or other occupant or visitor of such unit owner, damage shall be caused to the common elements or to a unit owned by others, or maintenance, repairs or replacements shall be required which would otherwise be a common expense, then such unit owner shall pay for such damage and such maintenance, repairs and replacements as

may be determined by the Association, to the extent not fully covered by the Association's insurance.

(d) In the event any portion of the insurance proceeds paid to the Association is not used to repair, reconstruct or rebuild the damaged or destroyed property, the Association shall distribute the proceeds among the unit owners and their mortgagees (as their interests may appear) in the same proportion as common expenses are shared, unless the property is removed from unit ownership. If the property is removed from unit ownership, the insurance proceeds, together with the proceeds from the sale of the property, shall be distributed to the unit owners and their mortgagees (as their interests may appear) in the manner described in the Oregon Condominium Act.

7.4 **Condemnation.** If any portion of the Condominium is made the subject matter of any condemnation or eminent domain proceeding or is otherwise sought to be acquired by a condemning authority, notice of the proceeding or proposed acquisition shall promptly be given to each unit owner and to each mortgagee and any eligible mortgage insurer or guarantor. The Association shall represent the unit owners in any condemnation proceedings or in negotiations, settlements and agreements with the condemning authority for acquisition of any portion of the common elements, and each unit owner appoints the Association to act as his attorney-in-fact for such purposes. All compensation, damages or other proceeds of the taking, other than any award for moving expenses of specific unit owners, shall be payable to the Association and allocated and distributed as provided in this Section 7.4.

(a) **Complete Taking.** If the entire Condominium property is taken, or if unit owners holding ninety percent (90%) of the voting power agree that such substantial portion of the Condominium has been taken as to make the project obsolete, then the property shall be deemed removed from unit ownership. In such event, any proceeds of the condemnation paid to the Association, together with any other proceeds upon sale of the remaining Condominium property, shall be distributed among the unit owners and their mortgagees, as their interests may appear, in accordance with the provisions of the Oregon Condominium Act.

(b) **Partial Taking.** If less than the entire Condominium property is taken and the property is not determined to be obsolete as provided in paragraph (a) above, then as soon as practicable the board of directors shall, reasonably and in good faith, allocate the award among the units in accordance with the reduction in the value of each unit and its interest in the common elements, compared to the total reduction in value of all units and their interest in the common elements. In the event any unit owner or mortgagee objects to the allocation determined by the board of directors, the matter shall be submitted to arbitration in accordance with the rules of the American Arbitration Association. The cost of such determination shall be paid out of the proceeds of the condemnation. Any portion of the award allocated to a unit owner under this paragraph shall be paid first to all mortgagees and holders of liens on the unit owner's interest in accordance with the existing priorities, and the balance to the unit owner. If any reconstruction or repair is undertaken as a result of the condemnation, the board of directors may retain and apply such portion of each unit owner's share of the award as is necessary to discharge the owner's liability for any special assessment arising from such reconstruction or repair.

7.5 **Restrictions and Requirements Respecting Use of Condominium Property.**

The following restrictions and requirements are in addition to all other restrictions and requirements contained in the Declaration and these Bylaws:

(a) **Permitted uses.** All units, other than Units L01, 104, 105 and 106, shall be used for residential purposes only.

(b) **Use of common elements.** The common elements shall be used for the furnishing of services and facilities for which the same are reasonably intended, for the enjoyment of the units. The use, operation and maintenance of the common elements shall not be obstructed, damaged or unreasonably interfered with by any unit owner.

(c) **Offensive or unlawful activities.** No noxious or offensive activities shall be carried on in any unit nor shall anything be done in or placed upon any unit or common element which interferes with or jeopardizes the enjoyment of other units or the common elements or which is a source of annoyance to residents. Unit occupants shall exercise extreme care not to make noises which may disturb other unit occupants, including the use of musical instruments, radios, televisions and amplifiers. Speakers for audio equipment may not be mounted on or against walls or floors without an adequate sound barrier to prevent vibration and transmission of bass sounds outside of the unit. Occupants may not discard or throw items out of windows or from decks, including, without limitation cigarettes or ashes. No unlawful use shall be made of the Condominium nor any part thereof, and all valid laws, zoning ordinances, and regulations of all governmental bodies having jurisdiction thereof shall be observed.

(d) **Animals.** No animals or fowls shall be raised, kept or permitted within the Condominium or any part thereof, except domestic dogs, cats, or other household pets kept within a unit. No such dogs, cats or pets shall be permitted to run at large nor shall be kept, bred or raised for commercial purposes or in unreasonable numbers. Any inconvenience, damage or unpleasantness caused by such pets shall be the responsibility of the respective owners thereof, and owners shall be responsible for removal of wastes of their animals. All dogs shall be carried or kept on a leash while outside a unit. No pet shall be permitted to cause or create a nuisance or unreasonable disturbance or noise. A unit owner may be required to remove a pet upon receipt of the third notice in writing from the board of directors of violations of any rule, regulation or restriction governing pets within the Condominium.

(e) **Exterior lighting or noisemaking devices and antennas.** Except with the consent of the board of directors of the Association, no exterior lighting or noisemaking devices shall be installed or maintained on any unit. Seasonal holiday lighting and decorations are permissible if consistent with any applicable rules and regulations and if removed within thirty (30) days after the celebrated holiday. Exterior antennas, satellite receiver and transmission dishes and other communication devices shall not be permitted to be placed upon the general common elements, and may not be placed on any unit or limited common element except in accordance with rules established by the board of directors.

6-26-03

(f) **Windows, balconies, patios, entries and entry doors and outside walls.**

In order to preserve the attractive appearance of the Condominium the board of directors of the Association may regulate the nature of items which may be placed in or on windows, balconies, patios, entries and entry doors and the outside walls so as to be visible from other units, the common elements, or outside the Condominium. Garments, rugs, laundry, sheets, reflective surfaces and other similar items may not be hung from windows, facades, patios or balconies. Only uniform window blinds approved by the board of directors are permitted, and any additional window coverings inside of the blinds must have white backings.

(g) **Leasing and rental of units.**

No unit owner may lease or rent less than his or her entire unit and no unit owner may rent such owner's unit for transient or hotel purposes, or for a period of less than 30 days. All leases or rentals shall be by written lease agreement, which shall provide that the terms of the lease shall be subject in all respects to the provisions of the Declaration and these Bylaws, and that any failure by the lessee or tenant to comply with the terms of such documents shall be a default under the lease. If the board of directors finds that a lessee or tenant has violated any provision of the Declaration, these Bylaws or the rules and regulations, the board may require the unit owner to terminate such lease or rental agreement. Other than the foregoing, there is no restriction on the right of any unit owner to lease or rent such owner's unit.

(h) **Signs.**

Unless written approval is first obtained from the board of directors, no sign of any kind shall be displayed to the public view on or from any unit or the common elements except signs used by the Declarant to advertise units for sale or lease. Ground floor Units L01, 104, 105 and 106 may have identifying signs meeting sign standards adopted by the board of directors.

(i) **Trash.**

No part of any unit or any part of the common elements shall be used or maintained as a dumping ground for rubbish, trash, garbage, recycling materials or other waste. No garbage, trash, recycling materials or other waste shall be kept or maintained on any part of the property, except in sanitary containers in the designated areas.

(j) **Insurance.**

Nothing shall be done or kept in any unit or in the common elements which will increase the cost of insurance on the common elements. No owner shall permit anything to be done or kept in his or her unit or in the common elements which will result in cancellation of insurance on any unit or any part of the common elements.

(k) **Water beds.**

Water beds may not be placed in any unit, except with the prior consent of the board of directors. If such consent is given, the unit owner shall carry insurance covering damage caused by the water bed and shall be responsible for all damages to any unit or the common elements which might be caused by the water bed.

(l) **Washing Machines.**

Each unit contains a washing machine hookup. The unit owner shall be responsible for all damages to any unit or the common elements that might be caused by the washing machine or leakage from the washing machine.

(m) **Association rules and regulations.**

In addition, the board of directors from time to time may adopt, modify, or revoke such rules and regulations governing the conduct of persons and the operation and use of the units and common elements as it may deem

necessary or appropriate in order to assure the peaceful and orderly use and enjoyment of the Condominium property. Such action may be modified by vote of not less than seventy-five percent (75%) of the voting rights present, in person or by proxy, at any meeting, the notice of which shall have stated that such modification or revocation or rules and regulations will be under consideration. A copy of the rules and regulations, upon adoption, and a copy of each amendment, modification or revocation thereof, shall be delivered by the secretary promptly to each unit owner and shall be binding upon all unit owners and occupants of all units from the date of delivery.

7.6 **Abatement and Enjoining of Violations.** The violation of any provision of the Declaration or these Bylaws, of any rule or regulation adopted pursuant to these Bylaws, or of any decision of the Association made pursuant to such documents, shall give the board of directors, acting on behalf of the Association, the right, in addition to any other rights set forth in these Bylaws, to do any or all of the following after giving written notice and an opportunity to be heard:

(a) to summarily abate and remove, at the expense of the defaulting unit owner, any structure, thing, or condition that may exist contrary to the intent and meaning of such provisions, and the board of directors shall not thereby be deemed guilty of any manner of trespass, provided, however, that judicial proceedings shall be instituted before any items of construction may be altered or demolished; or

(b) to enjoin, abate, or remedy such thing or condition by appropriate legal proceedings;

(c) to levy reasonable fines based upon a resolution adopted by the board of directors that is delivered to each unit, mailed to the mailing address of each unit or mailed to the mailing address designated by the owner of each unit in writing; or

(d) to terminate the right to receive utility services paid for out of assessments or the right of access to and use of recreational and service facilities of the Condominium until the correction of the violation has occurred.

The offending unit owner shall be liable to the Association for a reasonable administrative fee as established by the board of directors and all costs and attorneys' fees incurred by the Association, whether or not legal proceedings are instituted and including attorneys' fees at trial, in arbitration or on appeal or petition for review, together with any expense incurred by the Association in remedying the default, damage incurred by the Association or unit owners, or fines so levied. Such sums shall be assessed against the offending unit as an assessment and enforced as provided in Article 5. In addition, any aggrieved unit owner may bring an action against such other unit owner or the Association to recover damages or to enjoin, abate, or remedy such thing or condition by appropriate legal proceedings.

Article 8

Insurance

8.1 **Types of Insurance.** For the benefit of the Association and the unit owners, the board of directors shall obtain and maintain at all times, and shall pay for out of the common expense funds, the following insurance:

(a) **Property Damage Insurance.**

(i) The Association shall maintain a policy or policies of insurance covering loss or damage from fire, with standard extended coverage and "all risk" endorsements, and such other coverages as the Association may deem desirable.

(ii) The amount of the coverage shall be for not less than one hundred percent (100%) of the current replacement cost of the units and common elements (exclusive of land, foundation, excavation and other items normally excluded from coverage), subject to a maximum deductible of the lesser of \$10,000 or one percent (1%) of the policy amount.

(iii) The policy or policies shall include all fixtures and building service equipment to the extent that they are part of the common elements and all personal property and supplies belonging to the Association, together with all fixtures, improvements and alterations comprising a part of each unit.

(iv) Such policy or policies shall name the Association as insured, and shall provide for loss payable in favor of the Association, as a trustee for each unit owner and each such unit owner's mortgagee, as their interests may appear. The policies shall contain the standard mortgage clause, or equivalent endorsement (without contribution) which is commonly accepted by institutional mortgage investors in Oregon.

(b) **Liability Insurance.**

(i) The Association shall maintain comprehensive general liability insurance coverage insuring the Declarant, the Association, the board of directors, the unit owners and the managing agent, against liability to the public or to the owners of units and of common elements, and their invitees or tenants, incident to the operation, maintenance, ownership or use of the property, including legal liability arising out of lawsuits related to employment contracts of the Association. There may be excluded from such policy or policies coverage of a unit owner (other than as a member of the Association or board of directors) for liability arising out of acts or omission of such unit owner and liability incident to the ownership and/or use of the part of the property as to which such unit owner has the exclusive use or occupancy.

(ii) Limits of liability under such insurance shall not be less than One Million Dollars (\$1,000,000) on a combined single limit basis.

(iii) Such policy or policies shall be issued on a comprehensive liability basis and shall provide a cross liability endorsement wherein the rights of named insured

PortInd1-2116690.3 0040198-00002

6-26-03

under the policy or policies shall not be prejudiced as respects his, her or their action against another named insured.

(c) **Workers' Compensation Insurance.** The Association shall maintain workers' compensation insurance to the extent necessary to comply with any applicable laws.

(d) **Fidelity Insurance.**

(i) The Association shall maintain fidelity insurance for all officers, directors, trustees and employees of the Association and all other persons handling or responsible for funds of or administered by the Association. In the event the Association has retained a management agent, such agent shall maintain fidelity insurance for its officers, employees and agents handling or responsible for funds of, or administered on behalf of, the Association. The cost of such insurance shall be at the expense of the Association.

(ii) The total amount of fidelity insurance coverage required shall be based upon the best business judgment of the board of directors. In no event, however, may the aggregate amount of such insurance be less than the sum equal to three months' aggregate assessments on all units plus reserve funds.

(iii) Such fidelity insurance shall name the Association as obligee and shall contain waivers by the issuers of the insurance of all defenses based upon the exclusion of persons serving without compensation from the definition of "employees" or similar terms or expressions. The insurance shall provide that it may not be canceled or substantially modified (including cancellation for nonpayment of premium) without at least ten (10) days' prior written notice to the Association and each servicer on behalf of the Federal National Mortgage Association ("Fannie Mae").

(e) **Directors' and Officers' Liability Insurance.** The Association shall maintain a policy of directors' and officers' liability insurance with coverage in the amount of not less than One Million Dollars (\$1,000,000), subject to a reasonable deductible.

(f) **Insurance by Unit Owners.** The Association has no responsibility to procure or assist in procuring property loss insurance for any owner or tenant for (i) damage to a unit or limited common elements not covered by the Association's policy (because of the deductible amount or because the claim for loss or damage is one not covered by fire and property loss insurance policies required by these Bylaws or held by the Association); or (ii) for any damage or loss to the owner's or tenant's personal property. Owners must be responsible for purchasing insurance policies insuring their units and appurtenant limited common elements for the deductible amount under the Association's policies and for insuring their own personal property for any loss or damage. Proof of such insurance coverage must be provided to the Association by the unit owner. Tenants must be responsible for insuring their own personal property for any loss or damage. The Association shall notify all owners of the amount of the deductible under the Association policies. To the extent reasonably practicable, the Association shall give at least thirty (30) days' notice to the owners of any increase in the deductible proposed in renewal or replacement insurance policies. Owners and tenants of all units must procure and maintain comprehensive liability policies having combined limits in amounts

6-26-03

reasonably set by the Board of Directors no more often than every three years. Such insurance must provide coverage for, without limitation, the negligent acts of the owner and tenant and their guests or other occupants of the unit for damage to the general and limited common elements and other units and the personal property of others located therein.

8.2 **Other Insurance Requirements.** Insurance obtained by the Association shall be governed by the following requirements:

(a) All policies shall be written with the State of Oregon or a company licensed to do business in the State of Oregon acceptable to Fannie Mae which falls into a "B" or better general policyholder's rating or a "6" or better financial performance index rating in Best's *Insurance Reports*, an "A" or better general policyholder's rating and a financial size category of "VIII" or better in Best's *Insurance Reports - International Edition*, an "A" or better rating in Demotech's *Hazard Insurance Financial Stability Ratings*, a "BBBq" qualified solvency ratio or a "BBB" or better claims-paying ability rating in Standard and Poor's *Insurer Solvency Review*, or a "BBB" or better claims-paying ability in Standard and Poor's *International Confidential Rating Service*.

(b) Notwithstanding the provisions of Section 8.1 above, there may be named as an insured, on behalf of the Association, the Association's authorized representative, including any trustee with whom the Association may enter into any Insurance Trust Agreement, or any successor to such trustee. Such insurance trustee shall have exclusive authority to negotiate losses under any property or liability insurance policy. Each unit owner appoints the Association, or any insurance trustee or substitute trustee designated by the Association, as attorney-in-fact for the purpose of purchasing and maintaining such insurance including: the collection and appropriate disposition of the proceeds thereof, the negotiation of losses and execution of releases of liability, the execution of all documents, and the performance of all other acts necessary to accomplish such purchase. The Association or insurance trustee shall receive, hold or otherwise properly dispose of any proceeds of insurance in trust for unit owners and their first mortgage holders, as their interests may appear.

(c) All property insurance policies shall contain a "Special Condominium Endorsement" or its equivalent providing for the following: recognition of any Insurance Trust Agreement, a waiver of the right of subrogation against unit owners individually, that the insurance is not prejudiced by any act or neglect of individual unit owners which is not in the control of such owners collectively, and that the policy is primary in the event the unit owner has other insurance covering the same loss.

(d) For purposes of this article, insurance policies are unacceptable where (i) under the terms of the insurance carrier's charter, bylaws or policy, contributions or assessments may be made against Fannie Mae, the designee of Fannie Mae, or the Association or unit owners, or (ii) by the terms of the carrier's charter, bylaws or policy, loss payments are contingent upon action by the carrier's board of directors, policy holders or members, or (iii) policy includes any limiting clauses (other than insurance conditions) which could prevent Fannie Mae or the owners from collecting insurance proceeds.

(e) All policies required by this article shall provide that they may not be canceled or substantially modified without at least ten (10) days' prior written notice to the

Association and to each holder of a first mortgage which is listed as a scheduled holder of a first mortgage in the insurance policy. Evidence of insurance shall be issued to each unit owner and mortgagee upon request.

(f) Each unit owner shall be required to notify the board of directors of all improvements made by the owner to his or her unit, the value of which is in excess of Five Hundred Dollars (\$500). Nothing in this paragraph shall permit an owner to make improvements without first obtaining the approval of the board of directors pursuant to Section 7.2.

(g) Any unit owner who obtains individual insurance policies covering any portion of the property other than such owner's personal property and fixtures shall file a copy of such individual policy or policies with the Association within thirty (30) days after the purchase of such insurance.

8.3 **Optional Provisions.** The board of directors shall make every effort to secure insurance policies that will provide for the following:

(a) To the extent appropriate and available at reasonable cost, the Association shall maintain additional coverages against such other risks as are customarily covered with respect to projects similar in construction, location and use, including but not limited to, host liquor liability, contractual and all-written contract insurance, employer's liability insurance, comprehensive automobile liability insurance, and an endorsement patterned after "use and occupancy" insurance providing relief from monthly assessments while a unit is uninhabitable due to a covered loss.

(b) If reasonably available, the insurance policies shall include Inflation Guard Endorsement, and Construction Code Endorsements (such as a Demolition Cost Endorsement, a Contingent Liability from Operation of Building Laws Endorsement, and an Increased Cost of Construction Endorsement).

(c) A Steam Boiler and Machinery Coverage Endorsement if the Condominium has central heating or cooling, which coverage per accident shall at least equal the lesser of Two Million Dollars (\$2,000,000) or the insurable value of the building housing the boiler or machinery.

(d) Flood Insurance, if the Condominium is in a Special Flood Hazard Area.

(e) If reasonably available, waiver of subrogation by the insurer as to any claims against the board of directors, any unit owner or any guest of a unit owner.

8.4 **Fannie Mae and GNMA Requirements.** Notwithstanding any other provisions of this article, the Association shall continuously maintain in effect such casualty, flood and liability insurance and a fidelity bond meeting the insurance and fidelity requirements for condominium projects established by Fannie Mae and Government National Mortgage Association, so long as either is a mortgagee or owner of a unit within the Condominium, except to the extent such coverage is not available or has been waived in writing by Fannie Mae or Government National Mortgage Association. Fannie Mae or Fannie Mae's servicer, its successors and assigns, shall be named as a mortgagee in the Association's policies.

Article 9

Amendments to Bylaws

9.1 **How Proposed.** Amendments to the bylaws shall be proposed by either a majority of the board of directors or by unit owners holding thirty percent (30%) of the voting rights. The proposed amendment must be reduced to writing and shall be included in the notice of any meeting at which action is to be taken thereon or attached to any request for consent to the amendment.

9.2 **Adoption.** A resolution adopting a proposed amendment may be proposed by either the board of directors or by the unit owners and may be approved by the unit owners at a meeting called for this purpose or by ballot vote. Unit owners not present at the meeting considering such amendment may express their approval in writing or by proxy. Any resolution must be approved by unit owners holding a majority of the voting rights and by mortgagees to the extent required by the Declaration, except that (a) any provision of these Bylaws that is also contained in the Declaration must be approved by the same voting requirement for amendment of such provision of the Declaration, and (b) any amendment relating to age restrictions, pet restrictions, limitations on the number of persons who may occupy units, or limitations on the rental or leasing of units must be approved by unit owners holding seventy-five percent (75%) of the voting rights. Declarant's consent shall also be required so long as Declarant owns twenty-five percent (25%) or more of the units in the Condominium. Such consent shall not be required after three years from the date of conveyance of the first unit to a person other than Declarant. Any amendment which would limit or diminish any special Declarant rights established in these Bylaws shall require the written consent of Declarant, and any amendment to Sections 3.7, 3.16, 9.2 and 10.2 of these Bylaws shall require the written consent of Declarant for a period of ten (10) years after the date of the Organizational and Turnover Meeting described in Section 2.2.

9.3 **Execution and Recording.** An amendment shall not be effective until certified by the chairperson and secretary of the Association as being adopted in accordance with these Bylaws and the provisions of the Oregon Condominium Act and recorded as required by law. Any amendment adopted within five (5) years after the recording of the initial bylaws shall be approved by the Oregon Real Estate Commissioner to the extent required by the Oregon Condominium Act.

Article 10

Dispute Resolution

10.1 **Mediation.**

(a) Except as otherwise provided in this Section, before initiating litigation, arbitration or an administrative proceeding in which the Association and an owner have an adversarial relationship, the party that intends to initiate litigation, arbitration or an administrative proceeding shall offer to use any dispute resolution program available within Multnomah County, Oregon, that is in substantial compliance with the standards and guidelines adopted under ORS 36.175. The written offer must be hand delivered or mailed by certified

mail, return receipt requested, to the address, contained in the records of the Association, for the other party.

(b) If the party receiving the offer does not accept the offer within ten (10) days after receipt by written notice hand delivered or mailed by certified mail, return receipt requested, to the address, contained in the records of the Association, for the other party, the initiating party may commence the litigation, arbitration or the administrative proceeding. The notice of acceptance of the offer to participate in the program must contain the name, address and telephone number of the body administering the dispute resolution program.

(c) If a qualified dispute resolution program exists within Multnomah County, Oregon, and an offer to use the program is not made as required under paragraph (a) of this Section, litigation, arbitration or an administrative proceeding may be stayed for thirty (30) days upon a motion of the noninitiating party. If the litigation, arbitration or administrative action is stayed under this paragraph, both parties shall participate in the dispute resolution process.

(d) Unless a stay has been granted under paragraph (c) of this Section, if the dispute resolution process is not completed within thirty (30) days after receipt of the initial offer, the initiating party may commence litigation, arbitration or an administrative proceeding without regard to whether the dispute resolution is completed.

(e) Once made, the decision of the court, arbitrator or administrative body arising from litigation, arbitration or an administrative proceeding may not be set aside on the grounds that an offer to use a dispute resolution program was not made.

(f) The requirements of this Section do not apply to circumstances in which irreparable harm to a party will occur due to delay or to litigation, arbitration or an administrative proceeding initiated to collect assessments, other than assessments attributable to fines.

10.2 **Arbitration.** Any claim, controversy or dispute by or among Declarant (including members, officers, directors, shareholders and affiliates of Declarant), Association, the manager or managing agent, or one or more unit owners, or any of them, arising out of or related to the Declaration, these Bylaws or the Condominium shall be first subject to mediation as provided in Section 10.1 above or otherwise, and, if not timely settled by mediation, resolved by arbitration in accordance with this Article 10. The decisions and award of the arbitrator shall be final, binding and nonappealable. The arbitration shall be conducted in Portland, Oregon pursuant to the arbitration statutes of the State of Oregon and any arbitration award may be enforced by any court with jurisdiction. Filing for arbitration shall be treated the same as filing in court for purposes of meeting any applicable statute of limitations or for purposes of filing a notice of pending action ("lis pendens").

10.3 **Selection of Arbitrator.** The arbitration shall be conducted by a single arbitrator selected by mutual agreement of the parties. The arbitrator selected shall be neutral and unbiased, except to the extent the arbitrator's prior relationship with any party is fully disclosed and consented to by the other party or parties. If the parties are unable to agree upon the arbitrator within ten (10) days after a party's demand for arbitration, upon application of any party, the Presiding Judge of the Circuit Court of Multnomah County, Oregon shall designate the arbitrator.

10.4 **Consolidated Arbitration.** Upon demand by any party, claims between or among the parties and third parties shall be submitted in a single, consolidated arbitration.

10.5 **Discovery.** The parties to the arbitration shall be entitled to such discovery as would be available to them in an action in Multnomah County Circuit Court. The arbitrator shall have all of the authority of the Court incidental to such discovery, including without limitation authority to issue orders to produce documents or other materials, to issue orders to appear and submit to deposition, and to impose appropriate sanctions including without limitation award against a party for failure to comply with any order.

10.6 **Evidence.** The parties to the arbitration may offer such evidence as they desire and shall produce such additional evidence as the arbitrator may deem necessary for an understanding and determination of the dispute. The arbitrator shall determine the admissibility of the evidence offered. All evidence shall be taken in the presence of the arbitrator and all of the parties, except where any of the parties is absent in default or has waived its right to be present.

10.7 **Excluded Matters.** Notwithstanding the foregoing, the following matters shall not be subject to mediation or arbitration under this Article 10 (but shall be subject to the applicable provisions of Section 10.8 below): (a) actions relating to the collection of fees, assessments, fines and other charges imposed or levied by the Association (other than disputes as to the validity or amount of such fees, assessments, fines or charges, which disputes shall be subject to mediation/arbitration as provided above), and (b) actions to enforce any order, decision or award rendered by arbitration pursuant to this Article 10. The filing of a lis pendens or the application to any court for the issuance of any provisional process or similar remedy described in the Oregon or Federal Rules of Civil Procedure shall not constitute a waiver of the right or duty to utilize the procedures specified in this Article.

10.8 **Costs and Attorneys' Fees.** The fees of any mediator and the costs of mediation shall be divided and paid equally by the parties. Each party shall pay its own attorneys' fees and costs in connection with any mediation. The fees of any arbitrator and the costs of arbitration shall be paid by the nonprevailing party or parties; if none, such fees and costs shall be divided and paid equally by the parties. Should any suit, action or arbitration be commenced in connection with any dispute related to or arising out of the Declaration or these Bylaws, to obtain a judicial construction of any provision of the Declaration or these Bylaws, to rescind the Declaration or these Bylaws or to enforce or collect any judgment or decree of any court or any award obtained during arbitration, the prevailing party shall be entitled to recover its costs and disbursements, together with such investigation, expert witness and attorneys' fees incurred in connection with such dispute, as the court or arbitrator may adjudge reasonable, at trial, in the arbitration, upon any motion for reconsideration, upon petition for review, and on any appeal of such suit, action or arbitration proceeding. The determination of who is the prevailing party and the amount of reasonable attorneys' fees to be paid to the prevailing party shall be decided by the arbitrator (with respect to attorneys' fees incurred prior to and during the arbitration proceeding) and by the court or courts, including any appellate or review court, in which such matter is tried, heard or decided, including a court that hears a request to compel or enjoin arbitration or that hears exceptions made to an arbitration award submitted to it for confirmation as a judgment (with respect to attorneys' fees incurred in such proceedings).

10.9 **Survival.** The mediation and arbitration agreement set forth in this Article 10 shall survive the transfer by any party of its interest or involvement in the Condominium and any unit therein and the termination of the Declaration or these Bylaws.

Article 11

Miscellaneous

11.1 **Notices.** All notices to the Association or to the board of directors shall be sent care of the managing agent, or if there is no managing agent, to the principal office of the Association or to such other address as the board of directors may designate from time to time. All notices to any unit owner shall be sent to such address as may have been designated by such owner from time to time, in writing, to the board of directors, or, if no address has been designated, then to the owner's unit.

11.2 **Waiver.** No restriction, condition, obligation, or provision contained in these Bylaws shall be deemed to have been abrogated or waived by reason of any failure to enforce the same, irrespective of the number of violations or breaches thereof which may occur.

11.3 **Action Without a Meeting.** Any action which the Oregon Condominium Act, the Declaration or the bylaws require or permit the owners or directors to take at a meeting or ballot meeting may be taken without a meeting or ballot meeting if a consent in writing setting forth the action so taken is signed by all of the owners or directors entitled to vote on the matter.

The consent, which shall have the same effect as a unanimous vote of the owners or directors, shall be filed in the records of minutes of the Association.

11.4 **Invalidity; Number; Captions.** The invalidity of any part of these Bylaws shall not impair or affect in any manner the validity, enforceability or effect of the balance of these Bylaws. As used in these Bylaws, the singular shall include the plural, and the plural the singular. The masculine and neuter shall each include the masculine, feminine and neuter, as the context requires. All captions are intended solely for convenience of reference and shall in no way limit any of the provisions of these Bylaws.

11.5 **Conflicts.** these Bylaws are intended to comply with the Oregon Condominium Act and the Declaration. In case of any irreconcilable conflict, such statute and document shall control over these Bylaws or any rules and regulations adopted hereunder.

DATED this 13th day of May, 2003.

MOSAIC PORTLAND CONDOMINIUM, LLC,
an Oregon limited liability company

By: Mosaic Properties Oregon, Inc.

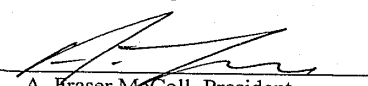
By: 
A. Fraser McColl, President

PortInd1-2116690.3 0040198-00002

AFTER RECORDING, RETURN TO:

Howard M. Feuerstein, Esq.
Stoel Rives LLP
900 SW Fifth Avenue, Suite 2600
Portland, OR 97204

Recorded in MULTNOMAH COUNTY, OREGON
C. Swick, Deputy Clerk
C59 4
Total : 36.00
2003-225313 09/22/2003 03:26:35pm
ATKLM

MOSAIC CONDOMINIUM

Amendment Transferring Storage Spaces

THIS AMENDMENT is made and executed this 18th day of September, 2003, by MOSAIC PORTLAND CONDOMINIUM, LLC, an Oregon limited liability company ("Declarant").

RECITALS

A. Declarant is the owner of Units L02, L03, 608 and 808 of Mosaic Condominium, a condominium located in Multnomah County, Oregon.

B. Exhibit C of the Declaration Submitting Mosaic Condominium to Condominium Ownership dated May 13, 2003 and recorded June 26, 2003 as Document No. 2003-147839 of the Records of Deeds of Multnomah County, Oregon (the "Declaration") assigns the limited common element storage spaces to the units in the condominium.

C. Declarant wishes to transfer certain storage spaces among the above units by exchanging the storage space assigned to Unit L02 for the storage space assigned to Unit L03, and the storage space assigned to Unit 608 for the storage space assigned to Unit 808.

NOW, THEREFORE, FOR VALUABLE CONSIDERATION, the receipt of which is hereby acknowledged, Declarant amends the above-described Declaration for the purpose of reassigning and conveying the following storage spaces to the following units so that the same shall hereafter be a limited common elements for the exclusive use of such units:

STORAGE SPACE	CURRENTLY ASSIGNED TO UNIT	TRANSFERRED TO UNIT
27	L03	L02
29	L02	L03
38	808	608
39	608	808

Portland-21-49541 1 004019S-00002

4

9-22-03

The storage spaces now assigned to such units are as follows:

UNIT	STORAGE SPACES
L02	27
L03	29
608	38
808	39

Attached to this Amendment is a revised Exhibit C setting forth the assignments of storage spaces incorporating the transfers contained in this Amendment.

MOSAIC PORTLAND CONDOMINIUM, LLC
an Oregon limited liability company
By Mosaic Properties Oregon, Inc.

By: *A. Fraser McColl*
A. Fraser McColl, President

STATE OF OREGON)
) ss.
County of)

The foregoing instrument was acknowledged before me this 18 day of Sept, 2003, by A. Fraser McColl, President of Mosaic Properties Oregon, Inc., an Oregon corporation, member of Mosaic Portland Condominium, LLC, an Oregon limited liability company, on its behalf.

[Signature]
Notary Public for Oregon *BRITISH COLUMBIA*
My commission expires: *N/A*
Commission No.:

LESLIE B. JAMIESON
Barrister & Solicitor
402-707 Fort Street
Victoria, B.C. V8W 2T6

LESLIE B. JAMIESON
Solicitor
Fort Street
Victoria, B.C. V8W 2T6



9-22-03

Mortgagee's Consent

The undersigned, as holder of a trust deed on Units L02, L03, 608 and 808, hereby consents to the above transfer.

HSBC BANK CANADA, an extra-national financial institution

By [Signature]
Name/Title VICE PRESIDENT

STATE OF OREGON)
)ss.
County of MULTNOMAH)

This instrument was acknowledged before me this 19th day of SEPTEMBER, 2003, by PAUL W. IP, VICE PRESIDENT of HSBC Bank Canada, an extra-national financial institution, on its behalf.

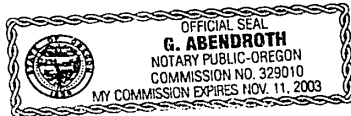

[Signature]
Notary Public for Oregon
My commission expires: NOV. 11, 2003
Commission No.: 329010

The foregoing Amendment Transferring Storage spaces is hereby approved this 22ND day of September, 2003.

ASSESSOR AND TAX COLLECTOR FOR MULTNOMAH COUNTY

By [Signature]

9-22-03

EXHIBIT C

Storage Space Assignments

<u>Unit</u>	<u>Storage Space</u>
L01	28
L02	27
L03	29
104	30
105	11
106	28
201	1
202	2
203	3
207	4
301	5
302	6
303	7
304	8
305	9
306	10
307	19
401	18
402	17
403	16
404	15
405	14
406	13
407	12
601	25
602	24
603	23
604	20
605	21
606	22
607	40
608	38
801	31
802	32
803	33
804	34
805	35
806	36
807	37
808	39

9-22-03

Recorded in MULTNOMAH COUNTY, OREGON
C. Swick, Deputy Clerk
J29 1 ATLJH
Total : 16.00

2005-152006 08/12/2005 09:32:40am

RECORDING REQUESTED BY

Mosaic Condominium Association

STATEMENT OF ASSOCIATION INFORMATION
Pursuant to ORS 94.667

The Board of Directors of Mosaic Condominium Association hereby places on record that the AGENT OF RECORD for the Homeowner's Association shall be notified prior to the title transfer of condominium/PUD units in the property described as:

PROPERTY DESCRIPTION IS RECORDED ACCORDING TO THE DULY RECORDED PLAT OF "MOSAIC CONDOMINIUM" FILED ON "JUNE 26, 2003" IN PLAT BOOK 1259, PAGES 3-10 RECORDS OF THE COUNTY OF "MULTNOMAH" AND STATE OF OREGON AND AS SHOWN ON THE PLAT MAP OF "MOSAIC CONDOMINIUM".

Prior to transfer of title, it will be necessary for the AGENT OF RECORD to provide vital information concerning unit ownership in this Association including the obligation of each homeowner to pay a monthly fee and the current status of each homeowners fulfillment of that obligation. The AGENT OF RECORD will issue instructions to escrow on behalf of the Homeowners Association for the collection of any maintenance fees or special assessments that must be paid prior to transfer of title.

The Escrow Company is hereby requested to provide detailed information to the AGENT OF RECORD pertaining to the closing date of all sales and resales, including the name and address of Seller(s) and the name, address and telephone number of Buyer(s) within ten (10) days of close of escrow.

All checks for payment of assessments are to be made payable to: Mosaic Condominium Association and mailed to the AGENT OF RECORD within ten (10) days of close of escrow.

AGENT OF RECORD: COMMUNITY MANAGEMENT, INC.
2105 SE 9th Avenue
Portland, Oregon 97214

Telephone: (503) 233-0300

By: Denise Bower
Denise Bower

Title: Vice President

STATE OF OREGON)
) SS
COUNTY OF MULTNOMAH)

On July 20, 2005 before me personally appeared Denise Bower, to me known to be the Community Manager of Mosaic Condo. Assoc. that executed the within instrument on behalf of the Association therein named, and acknowledged to me that such Association executed the within instrument pursuant to its Bylaws or a resolution of its Board of Directors.

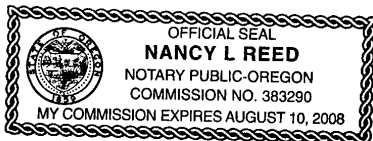

Nancy L Reed
Notary Public in and for said County and State

My Commission Expires: 8-10-2008

RETURN TO:
CMI
2105 S.E. 9TH AVENUE
PORTLAND, OR 97214